

Modular Precision Pressure Controller

CPC6000



OBSOLETE
Replaced by CPC6050





Warning

This Warning symbol indicates that danger of injury for persons and the environment and/or considerable material damage (mortal danger, danger of injury) will occur if the respective safety precautions are not taken.



Caution

This Caution symbol indicates danger for the system and material if the respective safety precautions are not taken.



Notice

This Notice symbol does not indicate safety notices but information for a better understanding of the facts.

Consult manual in all cases where these symbols and others are marked.

Table of Contents

1. General Information	7
1.1 Warranty	7
1.2 Important Notice	7
1.3 Compliance	8
1.4 Trademarks and Copyrights (C)	8
1.5 Software License Agreement	8
1.6 Mensor Service Plus	9
1.6.1 After the Warranty	9
1.6.2 Calibration Services	9
1.6.3 Certifications and Accreditations	9
1.7 Packaging for Shipment	9
2. Safety Notices	11
2.1 User Responsibilities	11
2.2. General Safety Notices	11
2.3 Warnings and Caution Notices	11
3. Product Description	13
3.1 General Description	13
3.2 Features	14
3.3 Front Panel	14
3.4 Display	15
3.5 Electrical Module	17
3.6 Pneumatic Module	18
3.7 Chassis Assembly	19
3.8 Electrical Block Diagram	20
4. Specifications	21
4.1 Measure Specifications	21
4.2 Control Specifications for the Pump Regulator Module	22
4.3 Control Specifications for the Solenoid Valve Regulator Module	23
4.4 General Specifications	24
5. Installation	25
5.1 Unpacking the System	25
5.2 Dimensions	25
5.3 Mounting	25
5.4 Rear Panel	26
5.5 Pressure Connections	26
5.5.1 Supply Port	27
5.5.2 Measure/Control Port	27
5.5.3 Exhaust Port	27
5.5.4 Reference Port	28

5.5.5 Remote Bus Connections	28
5.5.6 Digital I/O Connection	28
5.6 Turning on the CPC6000	28
6. Local Operation	29
6.1 General	29
6.2 Keys and Tabs	29
6.3 Display Screen Features	29
6.3.1 [i] Information Key	30
6.3.2 [Flag] Symbol	30
6.3.3 [▶] and [◀] Keys	31
6.3.4 Turndown Label and [Range Selector] Key	31
6.3.5 Pressure Label	32
6.3.6 Pressure [Units] Key	32
6.3.7 [Step Value] Key	33
6.3.8 Step Down [▼] and Step Up [▲] Keys	34
6.3.9 Control Pressure [Setpoint Value]	34
6.4 [Program] Key	35
6.4.1 Editing or Creating a Program	36
6.4.2 Running a Program	38
6.5 [Local] Label	39
6.6 [Setup] Key	39
6.6.1 [Channel] Setup	39
6.6.2 [Sensor] Setup	41
6.6.3 [Controller] Setup	41
6.7 Pump Regulator	42
6.8 Solenoid Valve Regulator	43
7. Remote Operation	45
7.1 Remote Setup	45
7.1.1 [Instrument] Setup Screen	45
7.1.2 [IEEE-488] Setup Screen	46
7.1.3 [Serial] Setup Screen	46
7.1.4 [Ethernet] Setup Screen	47
7.2 Ethernet Communication	47
7.3 IEEE-488 (GPIB)	47
7.3.1 Capability Codes	48
7.3.2 Interface Functions	48
7.4 RS-232 Serial Communication	48
7.4.1 Cable Requirements	48
7.4.2 Command and Query Format	49
7.4.3 Command Set Definitions	49
7.4.4 Output Formats	50

7.5 CPC6000 Command Set	51
7.5.1 CPC6000 Commands and Queries	51
7.5.2 CPC6000 Error Codes	58
7.6 Remote Emulation	60
7.6.1 PCS 400 Emulated Commands and Queries	60
7.6.2 PCS 200 Emulated Commands and Queries	61
7.6.3 SCPI Emulation	63
7.6.3.1 SCPI Commands and Queries	63
7.6.3.2 SCPI Commands Output Formats	65
7.6.3.3 SCPI Commands Error Messages and Error Codes	65
7.6.4 DPI 510 Emulation	66
7.6.4.1 DPI 510 Supported Commands and Queries	66
7.6.4.2 DPI 510 Unsupported Commands and Queries	68
7.6.4.3 DPI 510 Measurement Units	69
8. Options	71
8.1 Transport Case (PN 0011159001)	71
8.2 Rack Mount Kit	71
8.3 Calibration Sled Kit	72
8.4 Additional Transducers	72
8.4.1 Secondary Transducer Installation	72
8.5 Barometric Reference Transducer	72
8.5.1 Gauge Pressure Emulation Key	73
8.5.2 Absolute Pressure Emulation Key	73
8.5.3 Calibration	73
8.5.4 Specifications	73
8.6 Virtual Delta Channel	73
8.6.1 Delta Functions	73
8.6.2 Screen Source	74
8.6.3 Configure Button	74
8.6.4 Slave Channel Display	74
8.6.5 Screen Source A B	74
8.6.6 Screen Source A Delta	75
8.6.7 Screen Source Delta B	75
8.6.8 Delta Control Limits	76
8.6.9 Delta Units Type	76
8.6.10 Setup Screens	76
8.6.11 New Commands	76
8.7 Dual Solenoid Single Output	77

9. Maintenance	79
9.1 Beyond the Warranty	79
9.2 Troubleshooting the Pneumatic System of the CPC6000	80
9.2.1 Pump Regulator	80
9.2.2 Solenoid Valve Regulator	82
9.2.2.1 Tuning a Solenoid Valve Regulator Module	84
9.2.2.1.1 Modes	84
9.2.2.1.2 Tuning Procedure	85
9.3 Replacing Modules	85
9.3.1 Transducer Removal	86
9.3.2 Transducer Installation	87
9.3.3 Pneumatic Module Removal	87
9.3.4 Pneumatic Module Installation	87
9.4 Accessories	88
9.5 Chassis Interior	89
10. Calibration	91
10.1 General	91
10.2 Environment	91
10.3 Pressure Standards	91
10.4 Media	91
10.5 Calibration Setup	91
10.6 Password	93
10.6.1 Change Password	93
10.7 Restoring a Mensor Calibration	95
10.8 On-site Calibration	95
10.8.1 CPC6000 Preparation Procedure	95
10.8.2 [Calibrate] Setup Key	95
10.8.3 1-Point Calibration	97
10.8.4 2-Point Calibration	98
10.9 Head Pressure Correction	99
11. Appendix	101
11.1 Measurement Units	101
11.2 Conversion Factors, PSI	102
11.3 Conversion Factors, Millitorr	103
11.4 Conversion Factors, Pascal	104

1. General Information

1.1 Warranty

All products manufactured by Mensor are warranted to be free of defects in workmanship and materials for a period of one year from the date of shipment. No other express warranty is given, and no affirmation of Seller, by words or actions, shall constitute a warranty. SELLER DISCLAIMS ANY IMPLIED WARRANTIES OF MERCHANTABILITY OR FITNESS FOR ANY PARTICULAR PURPOSES WHATSOEVER. If any defect in workmanship or material should develop under conditions of normal use and service within the warranty period, repairs will be made at no charge to the original purchaser, upon delivery of the product(s) to the factory, shipping charges prepaid. If inspection by Mensor or its authorized representative reveals that the product was damaged by accident, alteration, misuse, abuse, faulty installation or other causes beyond the control of Mensor, this warranty does not apply. The judgment of Mensor will be final as to all matters concerning condition of the product, the cause and nature of a defect, and the necessity or manner of repair. Service, repairs or disassembly of the product in any manner, performed without specific factory permission, voids this warranty.

MENSOR MAKES NO WARRANTY OF ANY KIND WITH REGARD TO THIS MANUAL, INCLUDING, BUT NOT LIMITED TO, THE IMPLIED WARRANTIES OF MERCHANTABILITY AND FITNESS FOR A PARTICULAR PURPOSE. Mensor shall not be liable for errors contained herein or for incidental or consequential damages in connection with the furnishing, performance, or use of this material.

1.2 Important Notice

Please Note: The product specifications and other information contained in this manual are subject to change without notice.

Mensor has made a concerted effort to provide complete and current information for the proper use of the equipment. If there are questions regarding this manual or the proper use of the equipment, contact either Mensor or WIKA:

Mensor
201 Barnes Drive
San Marcos, Tx 78666

TEL: 1.512.396.4200
1.800.984.4200 (USA only)
WEB SITE: www.mensor.com
FAX: 1.512.396.1820
E-MAIL: sales@mensor.com
tech.support@mensor.com
quality@mensor.com

WIKA Alexander Wiegand SE & Co. KG
Alexander-Wiegand-Straße 30
D-63911 Klingenberg / Germany

TEL: (+49) 93 72/132-9986
WEB SITE: www.wika.de
FAX: (+49) 93 72/132-8767
E-MAIL: testequip@wika.de

Any reproduction of this manual or parts thereof by any means is prohibited.

1.3 Compliance

This equipment has been tested and found to comply with the European EMC directive (2004/108/EC) and FCC 47 CFR, Part 15, Subpart B Class A and the European Union Low Voltage Directive (73/23/EEC). The standards used to demonstrate compliance to these directives are:

EN55022 1998, A1:2000, A2:2003

EN55024 1998, A1:2001, A2:2003

61000-3-2 2000, A2 2005

61000-3-3 1995, A1 2001

IEC 61010-1:2010

These directives are designed to provide reasonable protection against harmful interference when the equipment is operated in a commercial environment. This equipment generates, uses, and can radiate radio frequency energy and, if not installed and used in accordance with the instruction manual, may cause harmful interference to radio communications. Operation of this equipment in a residential area is likely to cause harmful interference in which case the user will be required to correct the interference at his or her own expense.

Use shielded cables to connect external devices to this instrument to minimize RF radiation.

1.4 Trademarks and Copyrights (C)

Mensor is a registered trademark of Mensor. All other brand and product names are trademarks or registered trademarks of their respective companies. ©2006, Mensor. All rights reserved.

Korean font: Copyright (C) 1987, 1988; Daewoo Electronics Co., Ltd.

Chinese font: Copyright (C) 1988; The Institute of Software, Academia Sinica.

Correspondence address: P.O. Box 8718, Beijing, China 100080.

1.5 Software License Agreement

This product contains intellectual property, i.e., software programs, that are licensed for use by the end user/customer (hereinafter "end user").

This is not a sale of such intellectual property.

The end user shall not copy, disassemble or reverse compile the software program.



Notice

The software programs are provided to the end user "as is" without warranty of any kind, either express or implied, including, but not limited to, warranties of merchantability and fitness for a particular purpose. The entire risk of the quality and performance of the software program is with the end user.

Mensor and its suppliers shall not be held to any liability for any damages suffered or incurred by the end user (including, but not limited to, general, special, consequential or incidental damages including damages for loss of business profits, business interruption, loss of business information and the like), arising from or in connection with the delivery, use or performance of the software program.

1.6 Mensor Service Plus

If you have problems using your CPC6000 and you don't find the answer in this manual, contact Mensor at 1.800.984.4200 (USA only), or 1.512.396.4200 for personal assistance, or at any of the on-line addresses listed by touching the [i] information key on the screen header bar. We are ready to help.

1.6.1 After the Warranty

Mensor's concern with the performance of this instrument is not limited to the warranty period. We provide complete repair, calibration and certification services after the warranty for a nominal fee as explained in [Section 9](#), Maintenance.

1.6.2 Calibration Services

In addition to servicing our own products, Mensor provides complete pressure calibration services up to 20,000 psi for many pressure instruments. This service includes a Certificate of Compliance and Calibration and a record of traceability to the pressure standards of the United States National Institute of Standards and Technology (NIST).

1.6.3 Certifications and Accreditations

Mensor is registered to ISO 9001:2008. The calibration program at Mensor is accredited by A2LA, as complying with both the ISO/IEC 17025:2005 and the ANSI/NCSL Z540-1-1994 standards.

1.7 Packaging for Shipment

If the product must be shipped to a different location or returned to Mensor for any reason through a common carrier it must be packaged properly to minimize the risk of damage.

The recommended method of packing is to place the instrument in a container, surrounded on all sides with at least four inches of shock attenuation material such as styrofoam peanuts.

NOTES

2. Safety Notices

2.1 User Responsibilities

To ensure safety, the user must make sure that:

- The system is used properly, no dangerous media are used and that all technical specifications are observed.
- The system is operated in perfect operating condition.
- This operation manual is legible and accessible to the user at the system's location.
- The system is operated, serviced and repaired only by authorized and qualified personnel.
- The operator receives instruction on industrial safety and environmental protection, and is knowledgeable of the operating instructions and the safety notices contained therein.

2.2. General Safety Notices



Notice

The system should only be operated by trained personnel who are familiar with this manual and the operation of the instrument.



Warning

A condition for trouble-free and safe operation of this system is proper transport, proper storage, installation, assembly and proper use as well as careful operation and maintenance.

Any operation not described in the following instructions should be prohibited. The system must be handled with care required for an electronic precision instrument (protect from humidity, impacts, strong magnetic fields, static electricity and extreme temperatures). Do not insert any objects into the instrument.

The system is powered via the power cable with a voltage that can cause physical injury. Even after disconnecting the system from the power supply, dangerous voltages can temporarily occur due to capacitance.

Extreme care must be taken with pressure connections when using hazardous or toxic media.

Repairs must only be performed by authorized service personnel.



Notice

Additional safety notices are found throughout this manual.

2.3 Warnings and Caution Notices



Warning

WARNING: HIGH PRESSURE! High pressure gases are potentially hazardous. Energy stored in these gases can be released suddenly and with extreme force. High pressure systems should be assembled and operated only by personnel who have been trained in proper safety practices.



Warning

WARNING: POSSIBLE INJURY! The tubing, valves and other apparatus attached to the gauge must be adequate for the maximum pressure which will be applied, otherwise physical injury to the operator or bystanders is possible.



Caution

CAUTION: Use the proper pressure medium. Use only clean, dry, non-corrosive gases. This instrument is not designed for oxygen use.



Caution

CAUTION: Removing the supply pressure from a CPC6000 with high pressure trapped in the controller can possibly damage the regulator. Vent the CPC6000 before removing the supply pressure.



Warning

WARNING: HIGH SOUND LEVELS! Pressures from 1000 psi and up can generate sound levels above 80 dbA for brief periods when they are exhausted directly to atmosphere. It is the operator's responsibility to measure sound levels at whatever point 1 meter from the equipment that has the highest sound pressure level. At levels above 80 dbA, use of protective ear pieces can reduce these higher levels to a safe level.



Warning

WARNING: NOT EXPLOSION PROOF! Installation of this instrument in an area requiring devices rated as intrinsically safe is not recommended.



CAUTION: ESD PROTECTION REQUIRED. The proper use of grounded work surfaces and personal wrist straps are required when coming into contact with exposed circuits (printed circuit boards) to prevent static discharge damage to sensitive electronic components.



CAUTION: POSSIBILITY OF ELECTRIC SHOCK.



Warning

WARNING: Detachable main power supply cord with inadequate ratings should not be used. See Section 4.0, Specifications, for power supply ratings.



CAUTION: HOT SURFACE.



Consult operators manual.

Additional Warnings and Caution notices are found throughout this manual.

3. Product Description

3.1 General Description

The Mensor CPC6000 Modular Precision Pressure Controller is a multi-channel/multi-range pressure system designed to test and calibrate a variety of pressure devices in either absolute or gauge pressure modes. The CPC6000 can have two independent control channels each with its own pressure regulator. Each control channel can have up to two transducers. Transducers can be of two types: “**Intelliscale Transducers**” (IS) or “**Turndown Transducers**” (TD).

Intelliscale Transducers (IS) have an accuracy of 0.01%Intelliscale-50 (0.01%IS-50). This specification is a combination of % FS and %R with a 365 day recommended calibration interval and is explained in [Section 4](#) of this manual. The 0.01%IS-50 specification is available in all new CPC6000’s and applies to full scale ranges above 15 psi absolute or gauge. Bidirectional Intelliscale is limited to ranges above 145 psi. CPC6000s with software version 1.25 and below require a software upgrade to version 1.26 or greater to be able to communicate with Intelliscale Transducers.

Turndown Transducers (TD) can have two ranges configured on each transducer. These ranges are referred to as turndowns. The first turndown is the full span of the transducer, The second turndown cannot have a span that is less than 50% of the full span. Turndown Transducers can be used in all CPC6000 software versions.

Below is a software version comparison matrix.

	CPC6000 (software 1.25 and below)	CPC6000 (software 1.26 and above)
Transducer type	TD	IS or TD
Total Uncertainty (each range)	See Specification Section 4	See Section 4
Max. channels per instrument	2	2
Max. transducers per channel	2	2
Ranges per transducer	1 or 2	1 or 2
Max. ranges available	8	4 to 8
Barometer for emulation	Yes (optional)	Yes (optional)

Below is an example showing the uncertainty of a “Turndown Transducer” and an “Intelliscale Transducer”.

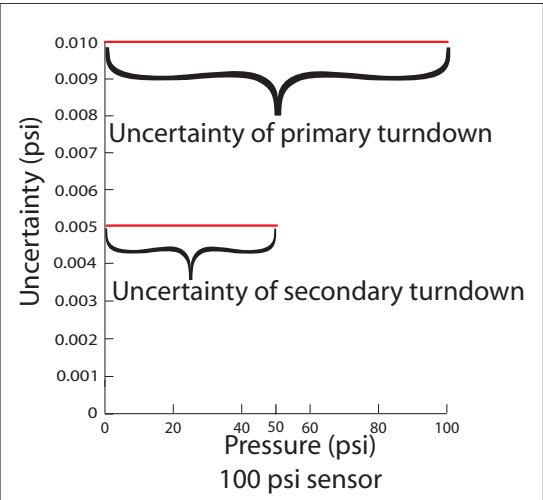

Turndown Transducer, all software versions

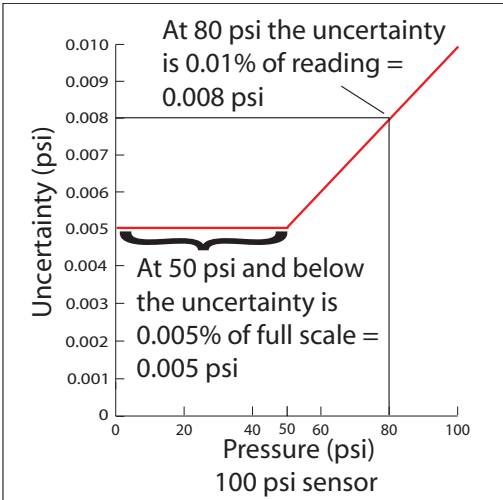

Intelliscale Transducers, Software >1.26

3.2 Features

Here is a short list of significant features designed into the CPC6000:

1. 0.01%Intelliscale-50 Uncertainty.
2. Up to four (two per channel) highly stable, temperature compensated, pressure transducers.
3. An optional internal high accuracy removable barometric reference transducer provides gauge pressure emulation for all of the absolute ranges and absolute pressure emulation for gauge ranges;
4. All pressure transducers are individually removable from the front of the CPC6000 without the use of tools. This feature greatly facilitates “out of instrument” recalibration of individual transducers using the optional Calibration Sled (see [Section 8](#), Options);
5. Two precision pressure regulators are selectable for controlled output pressure. These regulators have a history of excellent control and stability;
6. A separate electrical module using a high speed microprocessor. The operating program is loaded from a non-volatile flash disk;
7. A large color SVGA LCD display with a touch screen for intuitive operator interface;
8. Multiple languages; change the language for on-screen text and number/date formats instantly by simply touching one of the “national flag” cues available on the display The current language selections available are listed under [6.3.2](#) - Flag Symbol ‘in Section 6, Local Operation.

Operate the CPC6000 while it is either sitting on a bench or mounted in a standard equipment rack. Leveling the instrument is not a consideration since the pressure sensors are not affected by orientation. Use either front panel input (Local Operation), or send commands and queries over a bus from a separate “host” controller (Remote Operation).

3.3 Front Panel

The CPC6000 front panel (Figure 3.2) includes an 8.4 inch color SVGA display featuring touch screen technology. Operator input is accomplished by pressing the words or symbols presented on the display. There are no discrete keypads or switches on the front panel.

On the right hand side of the front panel, there is a clear window which shows the calibrated pressure ranges of the internal transducers and the instrument serial number.

To gain access to the internal modules simply loosen the two thumb screws on the right hand edge of the front panel and swing it open (Figure 3.3). In the front of the instrument directly below the electrical module are slots to accommodate two pressure transducer modules on each control channel. Each transducer can be removed and reinstalled through the front panel opening. See [Section 9.3.1](#), Transducer Removal, for additional information on module removal and replacement.



Figure 3.2 - Front panel



Figure 3.3 - Internal Access

3.4 Display

When the CPC6000 is powered up it takes about one minute for initialization, then displays a screen similar to Figure 3.4. The display is made up of rectangles which display text or symbols.

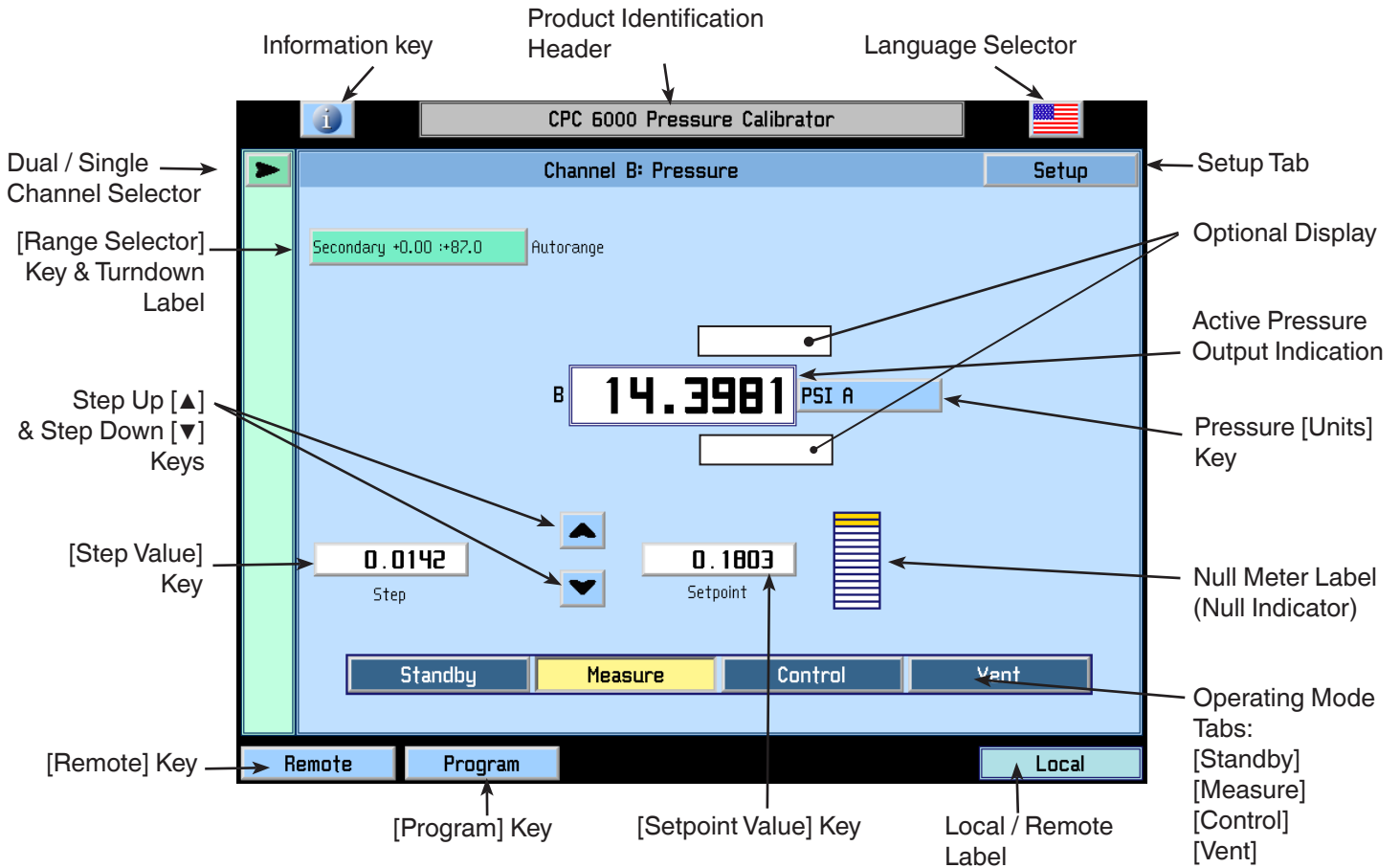

Figure 3.4 - Terminology of Screen Elements

Keys, Tabs, Labels or Windows: In this manual a key is a small rectangle which acts as a switch when pressed. Keys have borders with a three dimensional, shadowed effect. Tabs are a group of touch points, each of which will overlay most of the screen with one page related to its title subject. Labels or Windows are small rectangles with solid borders that display information, but do not respond to being touched.

Keys: Keys cause something to change when they are touched. Throughout this manual keys are represented with the displayed characters enclosed in brackets such as [PSI A]. Each key has a characteristic response when actuated; either an instant, single step response when the key is pressed, or continuously repeating steps while the key is held down, or a delayed response when released. Operators will quickly become accustomed to the particular characteristics of the frequently used keys. Some keys become labels under certain conditions, then resume their key function in other circumstances.

Header Bar: The bar across the top of the screen which displays the [i] information key, a title frame, and a national flag is stationary and remains displayed at all times. All of the number formats and text displayed on the CPC6000 screens will be in the language appropriate to the national flag displayed here such as American English for the USA flag, etc. Touch the flag to access a drop-down window showing all of the languages programmed into the CPC6000 (see [6.3.2](#) - Flag Symbol). Touch any flag to change the display to the corresponding language.

Optional Display: The optional display is a window near the pressure label. This window can be set up to be blank, or to display any one of the following:

- Peak Pressure – minimum and maximum
- Rate of change of a measured pressure
- Barometer reading

Footer Keys: Like the top bar, the [Remote] and [Program] keys on the bottom left corner of the display remain permanently on-screen. Touching either of these keys will cause that subject page to appear in the display.

3.5 Electrical Module

The electrical module is illustrated below with the instrument lid removed (Figure 3.5). All program information to run the system resides on a solid state disk module located on this module. The power switch and line fuses are situated on the rear of the electrical module such that they are accessible on the rear of the fully assembled CPC6000.

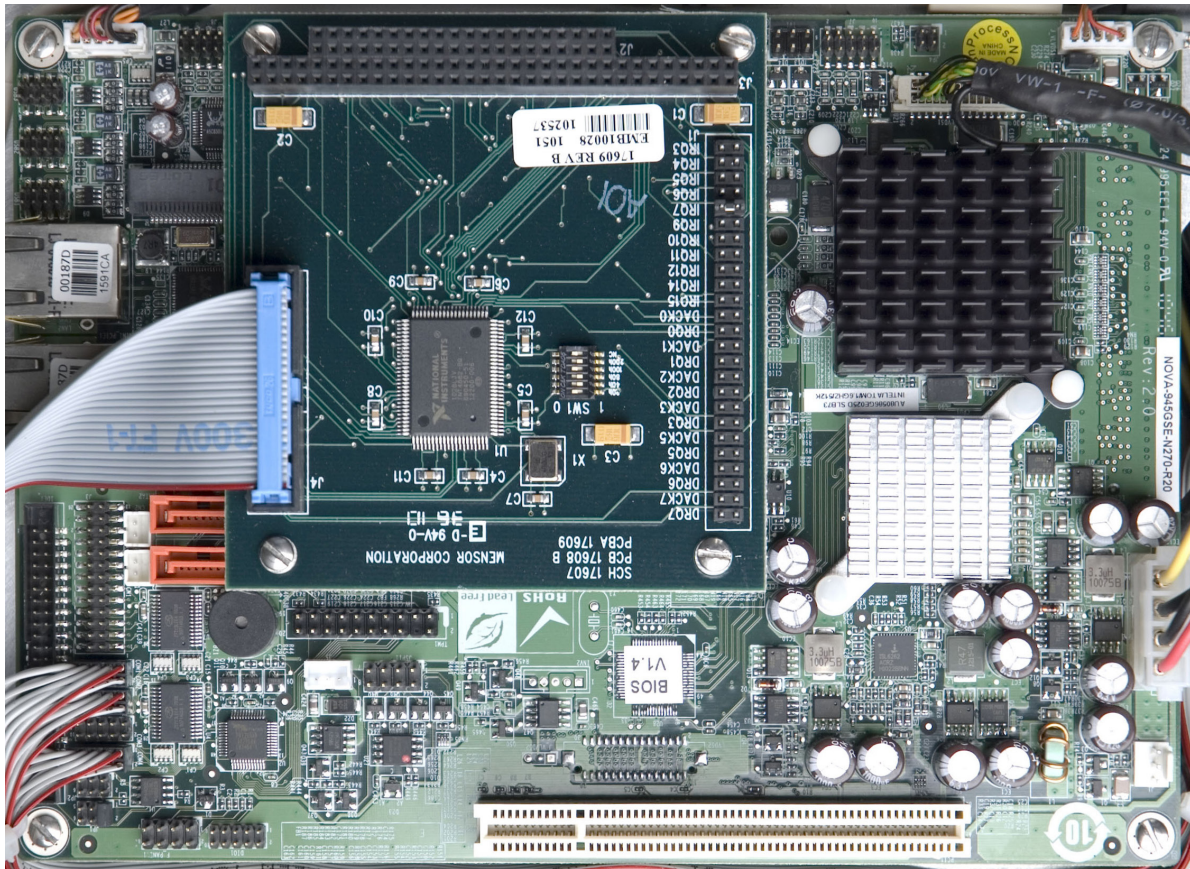

Figure 3.5 - Electrical Module

3.6 Pneumatic Module

Pneumatic modules come in two types and are referred to in this manual as the “Pump Regulator” or the “Solenoid Valve Regulator”. The pump regulator is used with low pressure sensors specified in [Section 4](#), Specifications. The solenoid valve regulator is used with higher pressure sensors and comes in three varieties:

- High Pressure Solenoid Valve Regulator (HP SVR)
- Medium Pressure Solenoid Valve Regulator (MP SVR)
- Low Pressure Solenoid Valve Regulator (LP SVR)

Pressure limits for all of these are specified in Section 4, Specifications.

Each pneumatic module (Figure 3.6) includes platforms for up to two high performance pressure transducers which are traceable to NIST standards. Both of these transducers can be used in conjunction with the highly stable pressure regulator to produce a precise pressure output. Each transducer includes its own on-board compensation and calibration data so that any transducer can be replaced in the instrument without requiring a recalibration.

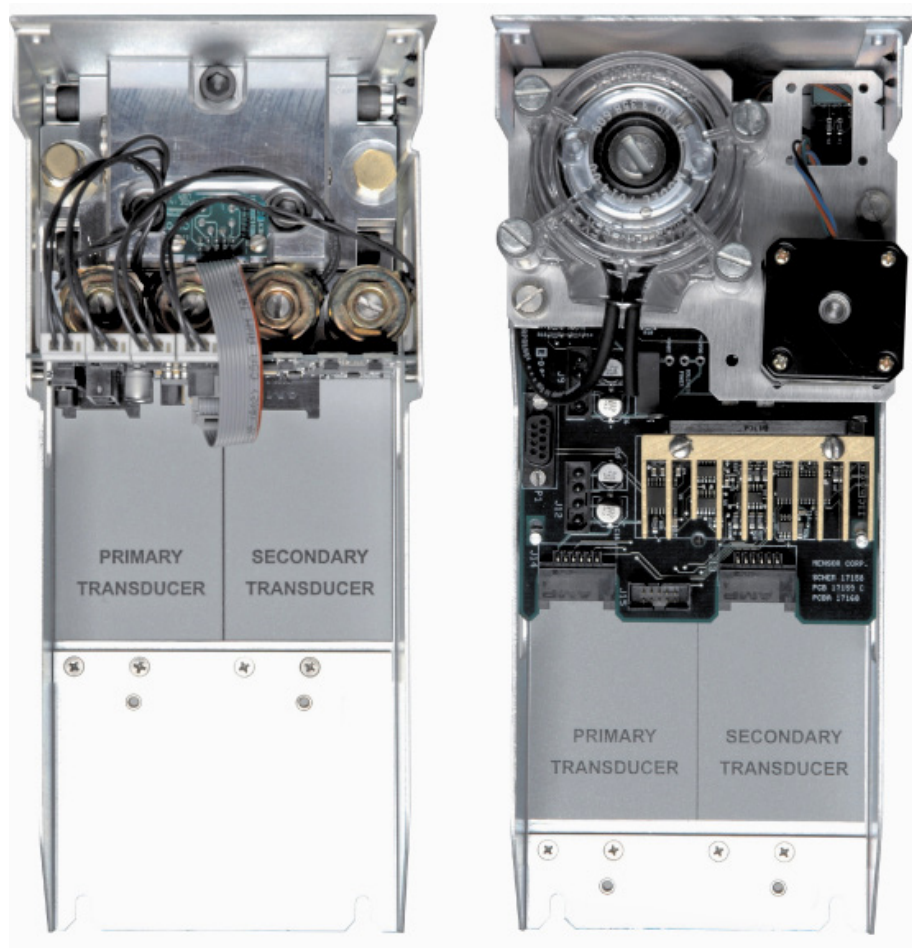

Figure 3.6 - Pneumatic Module

3.7 Chassis Assembly

The chassis assembly acts as the housing for the system. The electrical and pneumatic modules are each self-contained inside the chassis, and either can be replaced using basic hand tools. In addition, each pressure transducer is individually removable without tools. Instructions for transducer and module removal are provided in [Section 9](#), Maintenance.

The only moving parts in the CPC6000 are the fan, the pneumatic flow controller diaphragms and valves, the pump/motor, and the solenoid valve plungers. There are no internal user adjustments or setup switches.



Figure 3.7 - Chassis Assembly

3.8 Electrical Block Diagram

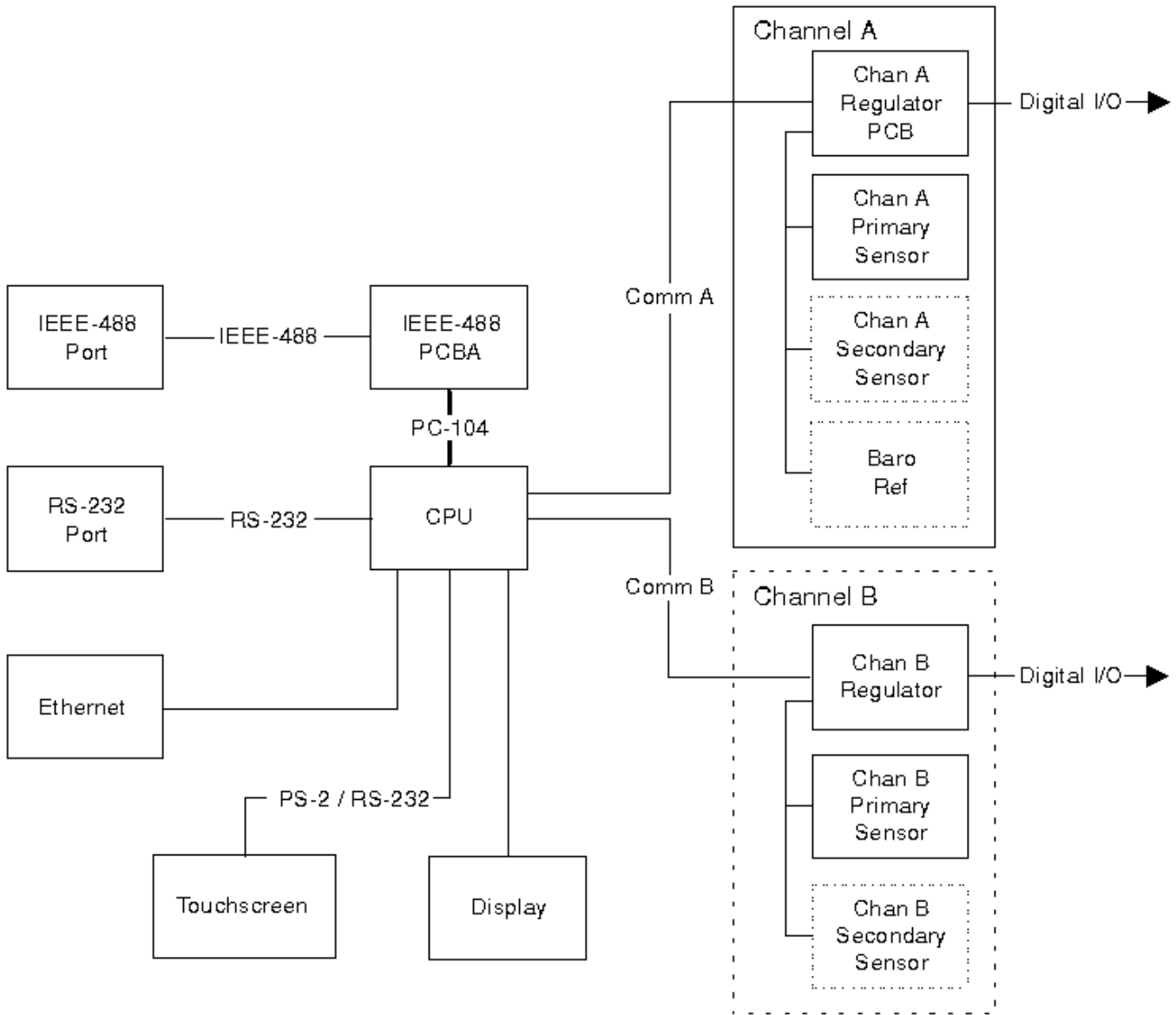

Figure 3.8 - Electrical Block Diagram

4. Specifications

Accuracy specifications presented herein are obtained by comparison with primary standards traceable to the National Institute of Standards and Technology (NIST). These specifications are obtained in accordance with the ISO Guide to the Expression of Uncertainty in Measurement (GUM). Any exception are noted on the individual calibration certificate.

Mensor reserves the right to change these specifications without notice.

4.1 Measure Specifications

Total Uncertainty	<p>Definitions: Max = the maximum value of a range, also known as the full scale value. Example, for a range of -15 ... 145, Max = 145 Min = the minimum value of a range. Example, for a range of -15 ... 145, Min = -15 Full Span (FS) = Max - Min. Example, for 0 ... 145 the Full Span is 145, for -15 ... 145 the Full Span is 160 Reading = The value of the sensor output TD = Turndown Transducers (TD) can have two ranges. The first is Min ... Max range The second cannot be less than 50% of the Max - Min and must be contained within the first range. IS = Intelliscale is a combination of %Max range and %Reading</p> <p>(1) Total Uncertainty (k=2) includes hysteresis, linearity, repeatability, reference standard, drift and temperature effects over the calibrated range for the calibration interval specified, with periodic re-zeroing. (2) 0.01% Intelliscale-50 (0.01% IS-50): Uncertainty from Min to 50% of Max = (0.010% x 50% x Max) or 0.010% of Reading from 50% to 100% of Max. (3) 0.01% Full Span (0.01% FS) = Uncertainty of 0.01% of the Full Span. (4) 0.03% Full Span (0.01% FS) = Uncertainty of 0.03% of the Full Span.</p>
-------------------	--

Type		Gauge	
	Transducer Range (psig)	Total Uncertainty⁽¹⁾ (calibration interval)	
TD	0 ... 0.36 to 0 ... <1	0.03%FS ⁽⁴⁾ (180 days)	
TD	0 ... 1 to 0 ... <14.5	0.01%FS ⁽³⁾ (180 days)	
IS	0 ... 14.5 to 0 ... 1500	0.01%IS-50 ⁽²⁾ (365 days)	
TD	0 ... 14.5 to 0 ... 1500	0.01%FS ⁽³⁾ (365 days)	
Type		Absolute	
	Transducer Range (psia)	Total Uncertainty⁽¹⁾ (calibration interval)	
TD	0 ... 7.5 to 0 ... <14.5	0.01%FS ⁽³⁾ (180 days)	
IS	0 ... 14.5 to 0 ... 1515	0.01%IS-50 ⁽²⁾ (365 days)	
TD	0 ... 14.5 to 0 ... 1515	0.01%FS ⁽³⁾ (365 days)	
Type		Bidirectional	
	Transducer Range (psi)	Uncertainty (calibration interval)	
TD	-0.18 ... +0.18 to -0.5 ... 0.5	0.03%FS ⁽³⁾ (180 days)	
TD	-0.5 ... 0.5 to -5 ... +14.5	0.01%FS ⁽³⁾ (180 days)	
TD	-5 ... +14.5 to -15 ... +1500	0.01%FS ⁽³⁾ (365 days)	
IS	-15 ... 145 to -15 ... 1500	0.01%IS-50 ⁽²⁾ (365 days)	

Modular Precision Pressure Controller CPC6000

Pressure Ranges	Specific ranges within the range intervals are selected by the customer.
Optional Barometer Range	8 to 17 psia
Optional Barometer Uncertainty	0.01% of reading with a recommended calibration interval of 365 days
Measurement Units	psi, inHg @0C and @60F, inH2O @4C, 20C and 60F, ftH2O @4C, 20C and 60F, mTorr, inSW @0C, ft SW @0C, mSW @0C, atm, bar, mbar, mmH2O @4C and 20°C, cmH2O @4C and 20C, mH2O @4C, mmH2O @0C, cmHg @0C, Torr, hPa, kPa, Pa, MPa, dyn/sq cm, g/sq cm, kg/sq cm, oz/si, psf, tons/sq ft, tons/sq in, mHg @0C, %FS and 2 user-defined units. (See also “11.1 - Measurement Units Table” in Section 11 , Appendix).
Resolution	4 to 6 significant digits, user selectable.

4.2 Control Specifications for the Pump Regulator Module

External Pressure Requirements:

Source Requirements	Fast Mode: 10% over range of highest pressure transducer. Slow Mode: None. Note: The difference between the source pressure and the minimum controlled pressure must be less than 30 psi. Performance can be enhanced with a well-regulated source pressure.
Exhaust Requirements	Fast Mode: A vacuum source is required for sub-atmospheric pressure control. Slow Mode: None
Stability of Controlled Pressure	Fast and Slow Mode: 0.003% of span of active range, typically better than 0.001% of span 10 seconds after displaying stable flag.
Available Sensor Range	Fast Mode: Absolute: 0 to 7.5 psia to 0 to 30 psia Gauge: 0 to .36 psig to 0 to 15 psig Bidirectional: -.18 to +.18 psi to -atm to 15 psig Slow Mode: Absolute: 0 to 7.5 psia to 0 to 30 psia Gauge: 0 to .36 psig to 0 to 15 psig.
Minimum Controlled Pressure	Fast and Slow Mode: 0.05% FS or .05 psi over exhaust pressure, whichever is greater. The minimum control point on absolute ranges is .5 psia.
Pressure Control Rates	Fast Mode: Fast control mode uses the roughing valves. Slow Mode: Slow mode uses only the pump.
Control Time	Fast Mode: 10 seconds to stable flag for 10% FS step pressure change into a 50cc volume. Larger volumes can lengthen this time. Controlling to low absolute pressures will lengthen this time. Slow Mode: 15 seconds to stable flag for 10% FS step pressure change into a 50cc volume. Larger volumes can lengthen this time. Controlling to pressures less than 0.5 psia will lengthen this time.

Supply Consumption	Fast Mode: Zero after setpoint is reached. All supply gas is used for upscale pressure sample filling. Slow Mode: Zero
Measure to Control Offset	Fast and Slow mode: <0.0005% Span
Overshoot	<1% of active range.

4.3 Control Specifications for the Solenoid Valve Regulator Module

External Pressure Requirements:

Source Requirements	10% over range of highest pressure transducer or 20 psi over highest pressure transducer for a pressure channel, whichever is less. CAUTION: Removing the supply pressure from a CPC6000 with high pressure trapped in the controller can possibly damage the regulator. Vent the CPC6000 before removing the supply pressure.
Exhaust Requirements	A vacuum source is required for sub-atmospheric pressure control.
Stability of Controlled Pressure	0.003% of span on active range. Typically better than 0.001% of span 10 seconds after displaying stable flag.
Sensor Spans Available in each Regulator Type	LP SVR: 0-1 psig to 0-50 psig (0-5 psia to 0-50 psia). MP SVR: 0-10 psi to 0-150 psi. HP SVR: 0-75 psi to 0-1500 psi.
Minimum Control Pressure	0.05% FS or .025 psi over exhaust pressure, whichever is greater.
Control Time	Approximately 10 seconds to stable flag for 10% pressure change in highspeed mode Highspeed stable window: 0.006% of the active range Highspeed stable delay: 1 second Highspeed overshoot: less than 1% active range --> 5-7 seconds is achievable, safety factor of ~30% 25 seconds to stable flag for 10% pressure change in precision mode Precision stable window: 0.003% of the active range Precision stable delay: 4 seconds Precision overshoot: less than 0.1% active range --> 8-15 seconds is achievable, safety factor of ~40% These times are achieved using a 50cc volume. Larger volumes can lengthen this time. Controlling to pressures less than 5 psia can also lengthen this time.
Pressure Control Rates	Slow, Medium, Fast (default).
Supply Consumption	<2.5 scfh in steady-state control.

4.4 General Specifications

Size	14.02" wide x 7.55" high x 12.42" deep (35.61 cm x 19.2 cm x 31.55 cm). See Figure 5.2.
Weight	36 lbs. (16.33 kg) with all internal options.
Power Input Requirements	100-240 Vac, 47-63 Hz, 92 VA max. Fuses: 1.5A, 250V, Type T LITTLEFUSE 31301.5
Digital I/O	Pin 1: +5 Vdc, 100 mA max. Pin 2: Input TTL levels. Voltage input should be limited to > -0.3 Vdc and < +5.3 Vdc. Pin 3: Output pulled up to 5 Vdc with a 10k ohm resistor. Source limited to 450uA, Sink 10mA Pin 4: Ground.
Pneumatic Interfaces	7/16" – 20 female SAE. 1/8" FNPT adapters provided.
Particle Filters	The instrument has 40-micron filters on all pressure ports through the manifold. The barometric transducer has no filters.
Pneumatic Overpressure Protection	Sensors are protected by relief valves.
Compensated Temperature Range	15C to 45C.
Operating Temperature Range	0C to 49C. Note: This is not the compensated temperature range.
Storage Temperature Range	0C to 70C. Minimal vibration. Non-condensing humidity.
Local User Interfaces	8.4" color LCD display with 8 wire resistive touch screen.
Remote User Interfaces	RS-232 (which requires a null modem cable), Ethernet, and IEEE-488.1 are standard.
Warm-up	Approximately 15 minutes to achieve full accuracy depending on environment.
Reading Rate	Typically 32 readings per second.
Measure Response Time	<333 mS for FS step.
Orientation Effects	Negligible, can be removed with re-zeroing.
Operating Environment	5 to 95% RH non-condensing. Indoor use only. Altitudes up to 2000 meters.
Pressure Media	Clean, dry, non-corrosive, non-combustible, non-oxidizing gases. Not suitable for oxygen use.
Compliance	See section 1.3 Compliance
Options	Transport Case, Rack Mount Kit, Calibration Sled Kit, Secondary Transducer, Barometric Reference Transducer, Virtual Delta Channel

5. Installation

5.1 Unpacking the System

In addition to this manual you should have:

- CPC6000 Modular Precision Pressure Controller
- Power cord
- 1/8 inch FNPT fitting adapters fastened to rear panel
- Any accessories ordered
- An envelope containing the Calibration Certificate

Your new instrument was subjected to many hours of functional testing before it left the factory. In addition to testing, the unit was inspected for appearance prior to being packaged for shipment. Upon removal from its carton please examine the instrument for shipping damage. Report any apparent damage to the carrier immediately.

5.2 Dimensions



Figure 5.2 - Dimensions

5.3 Mounting

The instrument can be set up on a table top or it can be rack-mounted. Rack mount adapters are optional on the CPC6000 and require an adapter panel (see [“8.2 - Rack Mount Kit”](#) in Section 8, Options). The special sensors used in the CPC6000 are relatively insensitive to tilt and vibration. However to further assure stability and accuracy, avoid mounting the instrument on surfaces subject to excessive motor or machinery vibration.

5.4 Rear Panel

Up to eight pneumatic pressure ports are located horizontally across the rear panel (Figure 5.4). Positioned to the right of the pressure ports are the Ethernet, RS-232 and GPIB connector, the off/on switch, the line fuses, and a protective grill covering the ventilating fan.

Figure 5.4 shows a rear panel containing two solenoid valve regulator pneumatic modules. Rear panels may differ depending on what modules are installed.



Figure 5.4 - Rear Panel

5.5 Pressure Connections



Notice

When making up a connection to an o-ring adapter port use a back-up wrench to prevent over-stressing the threads in the manifold block.

All of the pressure ports on the rear are female 7/16 - 20 SAE/MS straight threads per MS16142 and SAE J514 table 14. They require a tube fitting boss seal with an o-ring per MS33656. Mensor provides female 1/8" NPT adapter fittings with the instrument. The pressure connections can be made to these adapters with the proper mating hardware. We recommend the use of either Loctite® Hydraulic Sealant or new teflon tape on the threads of any male pipe fitting. Do not use sealant on fittings sealed with an o-ring. The integrity of each seal is particularly important since even microscopic leaks can cause errors in pressure measurements. The rear panel connections and a complete pneumatic schematic, including the optional secondary transducer, are provided in the [Maintenance Section](#) (see Figures 9.2.1C and 9.2.2B). Requirements for connecting to the ports on the CPC6000 manifold are as follows:

5.5.1 Supply Port

Connect a source pressure to the SUPPLY port of each channel. See “Source Pressure” in [Section 4](#), Specifications, for supply pressure requirements for various pressure ranges.



Caution

CAUTION: Removing the supply pressure from a CPC6000 with high pressure trapped in the controller can possibly damage the regulator. Vent the CPC6000 before removing the supply pressure.



Caution

CAUTION: The control channels are completely independent. Separate supply pressures should be applied to the control channels based on the maximum pressure range of each channel. Applying source pressure higher than the recommended pressure can cause permanent damage to the control channel.



Notice

Performance can be enhanced with a well-regulated source pressure.

5.5.2 Measure/Control Port

Connect a device to be tested to the MEASURE/CONTROL port. In MEASURE mode the CPC6000 will precisely measure the pressure at this port.

A pressure value can be selected using the on-screen keypad. That pressure will then be output to the MEASURE/CONTROL port by switching to the CONTROL mode of operation.



Warning

WARNING: HIGH NOISE LEVELS! As pressure decreases compressed gas will escape out the exhaust port. For ranges above 600 psi high noise levels may result during such pressure releases. To overcome objectionable exhaust noise either install a muffler or route the port to a remote location.



Caution

CAUTION: Improper use of this equipment may impair protection provided by this instrument.

5.5.3 Exhaust Port

If sub-atmospheric control pressure is required a vacuum pump must be connected to the EXHAUST port. Otherwise, this port may be left open to atmosphere.

5.5.4 Reference Port

On gauge units this port is connected to the reference side of the transducer, and on absolute units it is internally capped. This port is normally left open to atmosphere but may be attached to a snubber assembly on very low pressure instruments.

5.5.5 Remote Bus Connections

See [Section 7](#), Remote Operation, for connections and commands for operation over ethernet, RS-232 serial port or IEEE-488.

5.5.6 Digital I/O Connection

The Digital I/O connection consists of four pins.

Pin 1: +5 Vdc

Pin 2: Input TTL levels. Voltage input should be limited to > -0.3 Vdc and $< +5.3$ Vdc.

Pin 3: Output, pulled up to 5V with a 10k ohm resistor. Source limited to 450uA, Sink 10mA.

Pin 4: Ground

(See 'Digital I/O' in [Specifications section](#).)

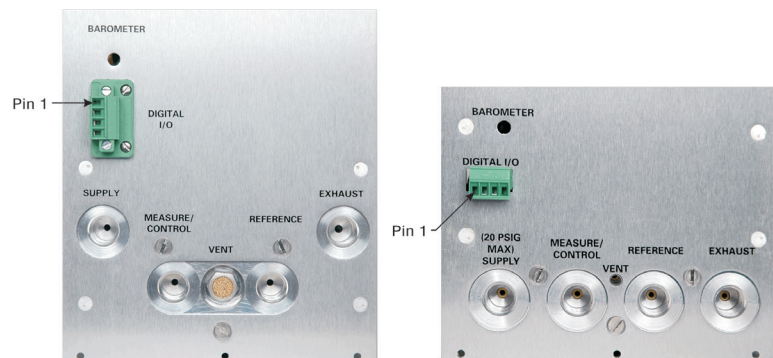

5.6 Turning on the CPC6000

After the pressure connections are secure, apply power to the power connector on the rear of the instrument and switch the power switch ON. The instrument will go through an initialization process and system check. As soon as the system check is completed the system will default to an operating screen similar to Figure 6.3B. Allow at least 15 minutes of warm up before performing critical pressure measurements.

If the CPC6000 regulator to be used is a pump and the autotune feature is to be used, then after the controller has warmed up, cycle the pressure from the minimum to the maximum then back to the minimum pressure of the primary sensor with the desired volume connected to the Measure/Control port. This will allow the pump regulator to accurately detect the external volume in use. See Section 6.7 "Pump Regulator" for more information.



Warning

WARNING: EARTH GROUND! Any power adaptors or surge protection devices that negate the protective earth ground should not be used.

The power cord is the disconnection device and its outlet should be accessible and contain a protective earth ground.



Warning

WARNING: VENTILATION! Do not block airflow to ventilating fan located on rear of instrument.

6. Local Operation

6.1 General

This section describes the procedures for operating the CPC6000 from the front panel. Instructions for operating the device remotely from an external computer are covered in the next section, [Remote operation](#). By following the procedures provided in these two sections and the [Calibration section](#), you can expect your CPC6000 to deliver maximum accuracy and dependability for many years of useful service.

6.2 Keys and Tabs

Local operation is accomplished by observing the data presented in the display, then pressing the on-screen [key] or [tab] for the desired function. Throughout this manual characters enclosed inside square brackets [] represent the associated on-screen touch point.

6.3 Display Screen Features

Figure 6.3A provides a brief description of the features shown on a single channel display.

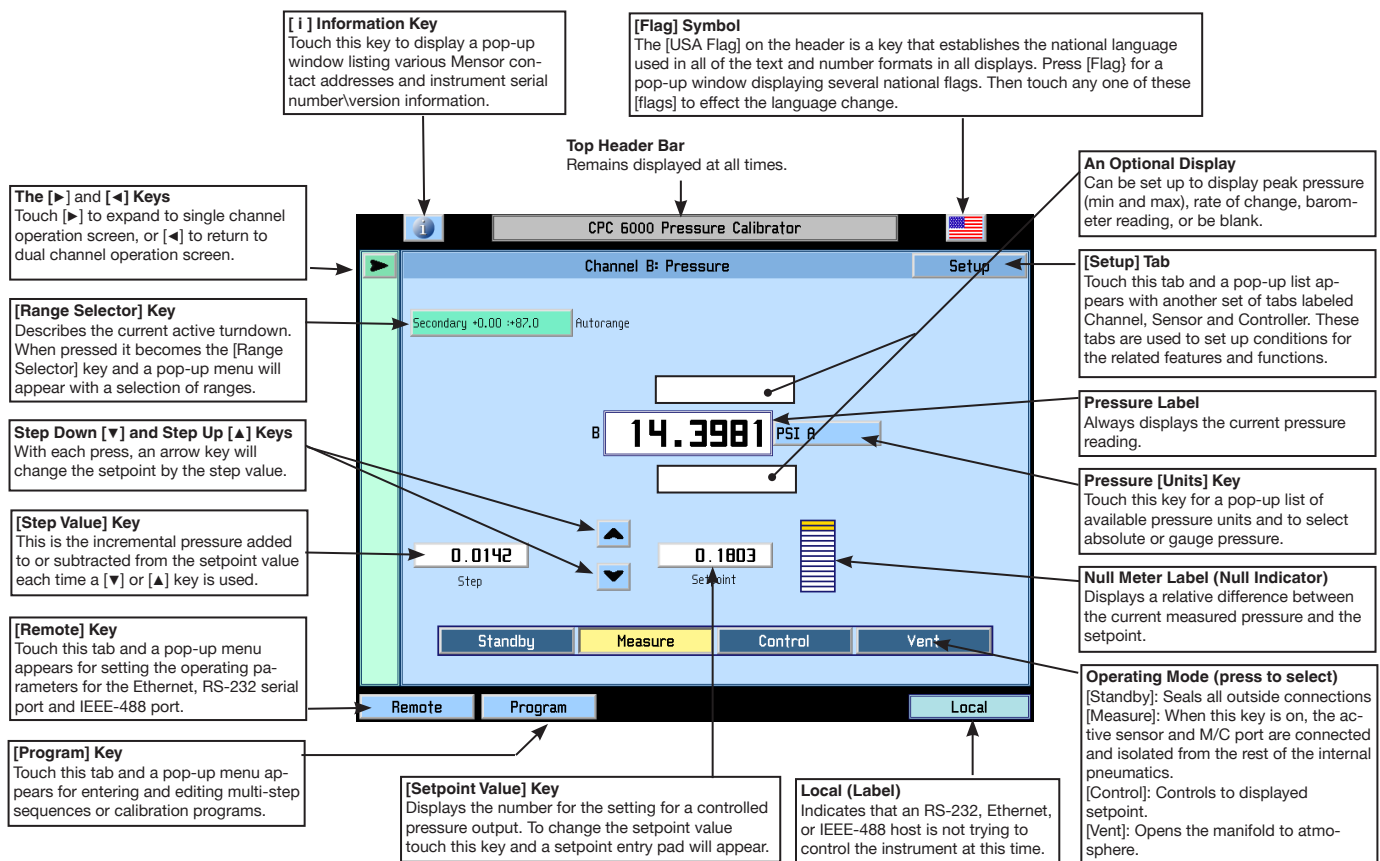

Figure 6.3A - Display Screen Features

Figure 6.3B is an example of a typical display after initialization. To expand the selected channel to a single channel operation screen as shown in Figure 6.3A, press the [▶] key. The [Standby] key appears on the screen when expanded. To expand or return to a dual channel operation screen press the [◀] or [▶] key.

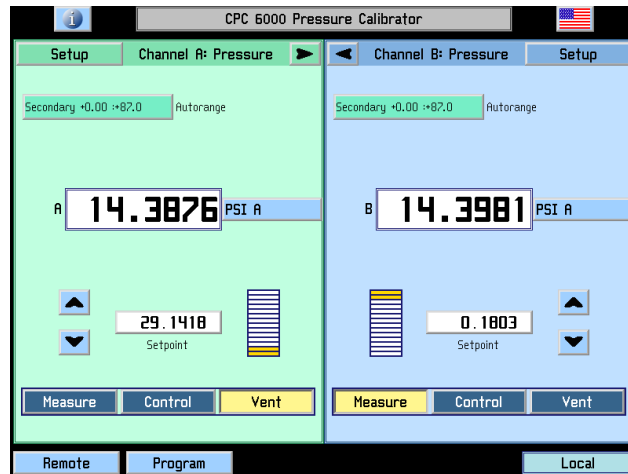

Figure 6.3B - Typical Operation Screen

All of the CPC6000 screen features are described in more detail in the rest of this section.

6.3.1 [i] Information Key

Touch the [i] information key on the header to display a pop-up window as shown in Figure 6.3.1 listing various Mensor contact addresses and CPC6000 serial number/version information. Touch [Close] to close the window.

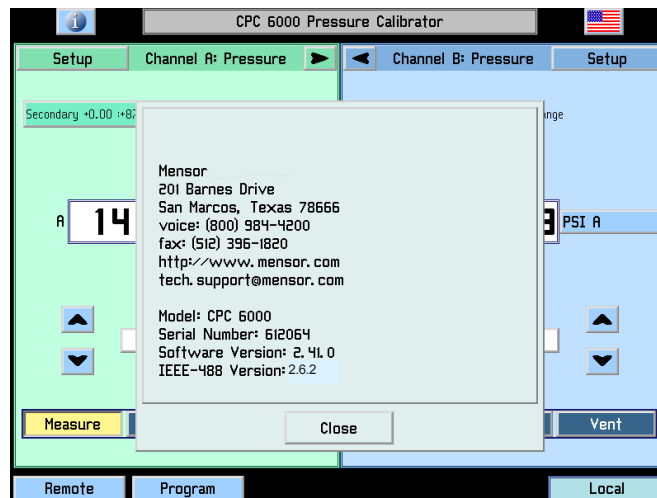

Figure 6.3.1 - Mensor Address/Contact Information Window

6.3.2 [Flag] Symbol

The [USA Flag] on the header is a key that establishes the national language used in all of the text and number formats in all displays. Press the [Flag] for a pop-up window displaying several national flags

(Figure 6.3.2). Touch any one of these [Flags] to effect the language change.
The current language selections available are:

Language	Country
English	USA
German	Germany
German	Switzerland
English	Great Britain
Chinese	China
English	Canada
French	France
French	Switzerland
English	Ireland
Korean	Korea
French	Canada
Italian	Italy
Russian	Russia
Polish	Poland
Japanese	Japan
Spanish	Mexico
Spanish	Spain
Portuguese	Portugal
Portuguese	Brazil

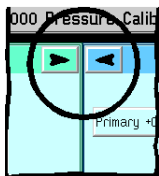

Figure 6.3.2 - Language Selection Window



The language selection acts on the screen displays only, and does NOT affect remote commands and responses. All remote dialogs listed in Section 7, Remote Operation, are literal as described.

6.3.3 [▶] and [◀] Keys



The [▶] and [◀] keys will expand the selected channel to single channel operation screen, or return to dual channel operation screen.

6.3.4 Turndown Label and [Range Selector] Key

The label in the upper left portion of Figure 6.3.4A describes the current active range as “Secondary +0.00 :+87.0”. This may be the full scale range of an Intelliscale transducer or a range in a Turndown Transducer. The label, when touched, becomes the [Range Selector] key. Different colors are used to distinguish primary and secondary transducers. The currently active range is highlighted with a yellow background. Touch any range other than the yellow one to select a different range as shown in Figure 6.3.4B. The last selection in this range selector is [Autorange], which will automatically switch to the most accurate range in the system capable of measuring the current pressure. Each change is immediately reflected in the turndown label. There is also a label beside the current active range to show if you are in range hold or autorange. Intelliscale Transducers and Turndown Transducers can be used simultaneously within the same channel. See Section 3.1 “General Description” for a more detailed description of Intelliscale Transducers and Turndown Transducers.



Notice

Some pressure units can cause a number to be too long for the value window. In those cases the value will be abbreviated with an “m” (milli), “k” (kilo), or “M” (mega) multiplier appended to the range in the range drop list.

An important feature of the CPC6000 is that transducers can easily be changed. A transducer can be replaced in the CPC6000 in less than 30 seconds, with no tools required. Each installed transducer identifies itself to the system using its on-board stored data. Among the items stored in this data are the transducer serial number, curve characterizations and calibrations for each turndown, the dates of calibration, and the transducer’s software version.



Notice

There is no alarm or signal that a transducer has been removed or exchanged. If security is an issue, a visible seal or calibration sticker might be placed on the front panel in such a manner that it must be broken to gain access to the transducers.

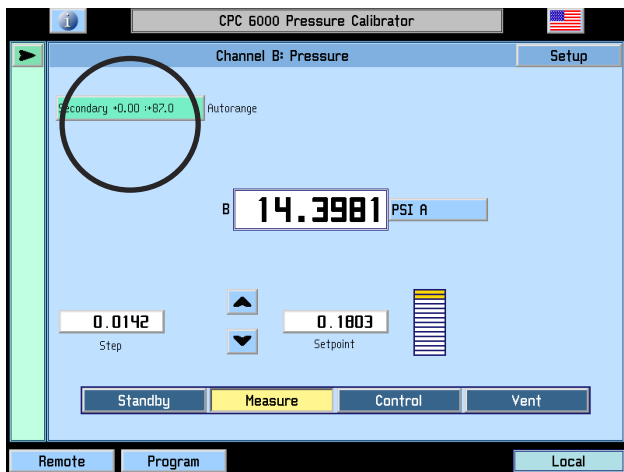

Figure 6.3.4A - [Turndown Label]

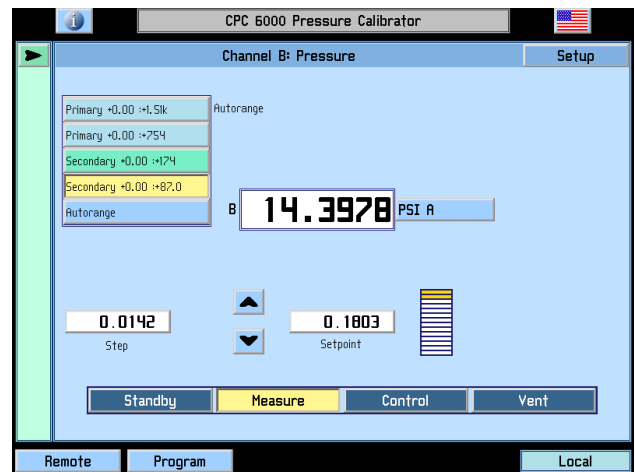

Figure 6.3.4B - [Range Selector] drop-down menu

6.3.5 Pressure Label

Below the turndown label shown in Figure 6.3.4A is a larger label in the center of the screen showing the measured pressure value. This large label always displays the current pressure reading.

6.3.6 Pressure [Units] Key

To the right of the pressure label is the [Units] key, shown in Figure 6.3.4A as [PSI]. Touch [PSI] and a pop-up menu of pressure units will appear as in Figure 6.3.6. This menu includes [User 1] and [User 2] keys allowing the user to enter customized pressure units. Touch [PSI] and it will toggle to Pascal. Press a [Value] key to enter a custom multiplier to equal either one PSI, or one Pascal, whichever is showing in the user multiplier base units key.

The upper right [absolute] or [gauge] key allows emulation mode if an optional barometric sensor is installed. See [Section 8](#), Options.

The current units are highlighted by a yellow background. Touch any other [Pressure Units] key, and press [OK] to enable change and return to previous operation screen. All of the displayed pressure values will have changed to correspond to the newly selected units at the correct conversion ratio.

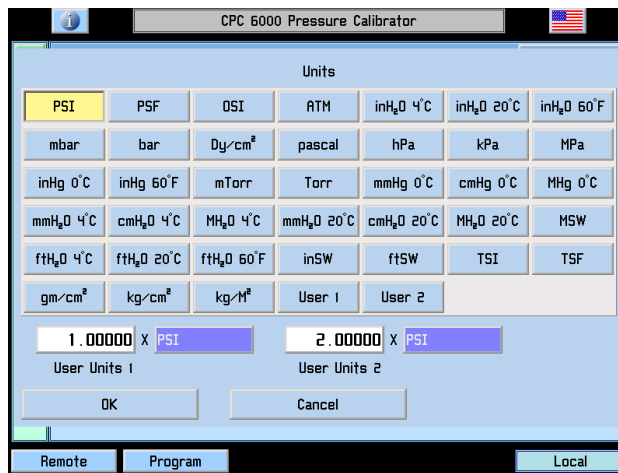

Figure 6.3.6 - Units Selection Window

6.3.7 [Step Value] Key

On the left side of the screen as seen in Figure 6.3A is the [Step Value] key. The step value displayed is 0.0142. This is the incremental pressure added to or subtracted from the setpoint value each time a [▼] or [▲] key is used on the main screen. To change the step value touch the [Step Value] key and the step entry pad as shown in Figure 6.3.7 will appear.

This number pad shows the maximum and minimum values applicable to the active turndown. There is also a Current Value and a New Value window. Enter a new step number and then press [OK], or else touch [Cancel] to return to the operate screen without changing the step value. Press CE to back-space.

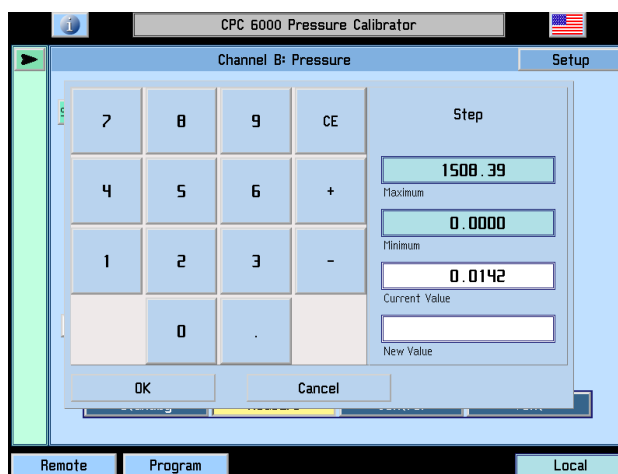

Figure 6.3.7 - Step Value Window (Single Channel)

6.3.8 Step Down [▼] and Step Up [▲] Keys

As shown in Figure 6.3A, the [▼] and [▲] keys are located to the side (different for A and B Channels) of the [Setpoint Value] key; one for Step Down [▼], and another for Step Up [▲]. Pressing an arrow key will change the setpoint by the step value until the control limits of the channel are reached.

6.3.9 Control Pressure [Setpoint Value]

The number displayed inside the [Setpoint Value] key is the setting for a controlled pressure output. When the [Control] key at the bottom of the active channel screen is switched to [On] the regulator will attempt to present that precise pressure to the Measure/Control port on the rear panel. The setpoint number is changed either by using the [▲] and [▼] keys, or by touching the [Setpoint Value] key to input a new number.

If the displayed number is beyond the range of a selected turndown in range hold mode, the number will change to a control value within the limits of the turndown. The setpoint will change in value automatically, but it will not be restored automatically if the previous turndown is reselected.

[Standby] key: When this key is ON all internal solenoid valves are closed.

[Measure] key: When this key is ON the active sensor and the Measure/Control port are connected and isolated from the rest of the internal pneumatics.

[Control] key: When this key is ON the unit will attempt to control to the setpoint displayed.

[Vent] key: When this key is ON the internal pneumatics are open to atmosphere.

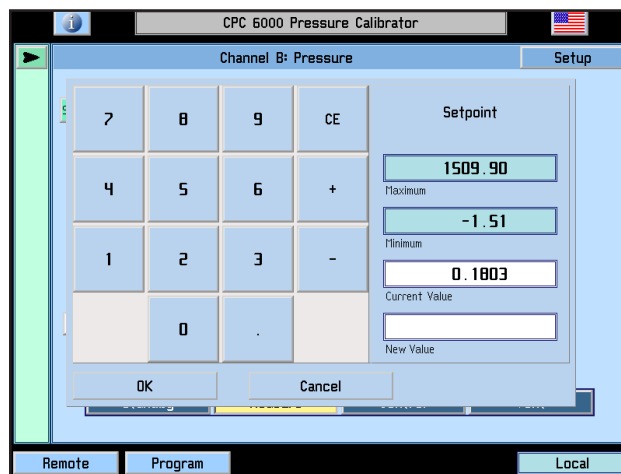

Figure 6.3.9 - [Setpoint Value] Window

6.4 [Program] Key

The [Program] key on the bottom left of the operation screen (see Figure 6.3B) enters the main program creation/edit screen shown in Figure 6.4A. Programmed multi-step sequences can be entered and edited from this screen. There are sample programs available in the instrument that can be edited and renamed. A saved program can be executed by entering the setup channel screen and selecting the [Program] key. The CPC6000 can store up to 64 programs with up to 100 steps in each program.

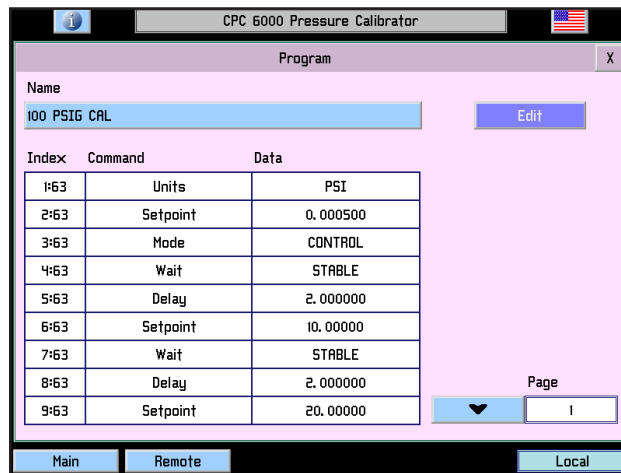

Figure 6.4A - Main Program Screen

The large key at the top of this screen contains the program name of the currently active program that can be run or edited. If this key is pressed, a list of saved programs will be displayed as shown in Figure 6.4B. The up and down arrow keys display additional pages of programs. To select a program to run or edit, simply press the name of the program.

To create a new program sequence, select a blank line and press [OK]. To copy an existing program, select the program to be copied, press [Copy], select a new line (or an existing program to overwrite) and press [Paste]. The [Delete] key erases a program from memory.

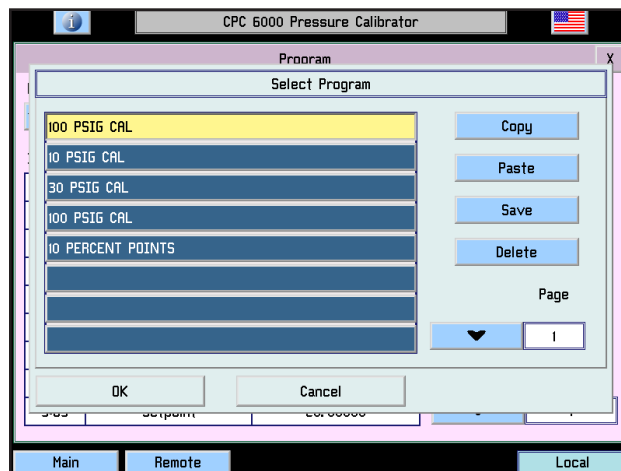

Figure 6.4B - Program Selection Screen

6.4.1 Editing or Creating a Program

To edit or create a program, select a program name from the Program Selection Screen and press [OK]. This brings up the main program screen. Below the [Name] key is a table that shows a synopsis of the program steps. There are also up and down arrow keys to display additional pages of program steps.

To edit the selected program press the [Edit] key. This displays the program editing screen shown in Figure 6.4.1A.

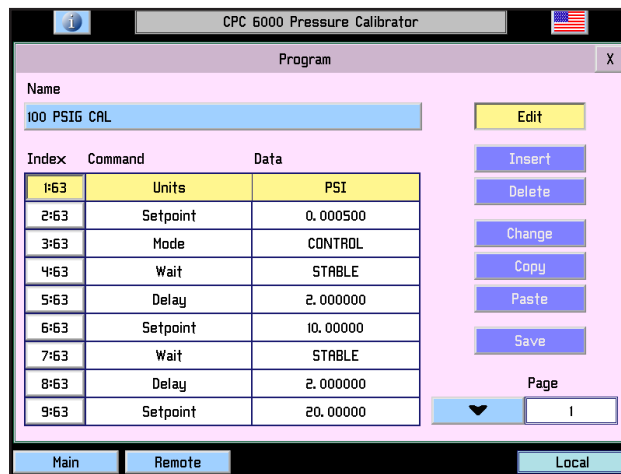

Figure 6.4.1A - Program Editing Screen

Each program line shown in Figure 6.4.1A only executes one function or command. Each line has an index number associated with it. For example, if a program has 30 commands, the first command index is 1:30 to represent that it is command one of 30 to be executed.

To edit individual program lines, select the index number of the program line to edit.

[Insert] key: inserts a new program line before the selected one. This also re-scales the index numbers accordingly.

[Delete] key: deletes the selected program line and re-scales the index numbers accordingly.

[Change] key: displays the program line edit screen as shown in Figure 6.4.1C . Its functionality is described in the following text.

[Copy] key: copies the selected program line.

[Paste] key: To paste a copied program line over an existing line, select the program line to be overwritten and press the [Paste] key.

[Save] key: saves the individual program lines to the program and the program to memory. If program lines are edited and the main program screen is exited without pressing the [Save] key, a warning dialog box is displayed prompting the user to save program changes or cancel.

To change the name of the program, press the [Name] key. This displays a keyboard screen shown in Figure 6.4.1B. Enter the name of the program and press [OK] to return to edit the program steps.

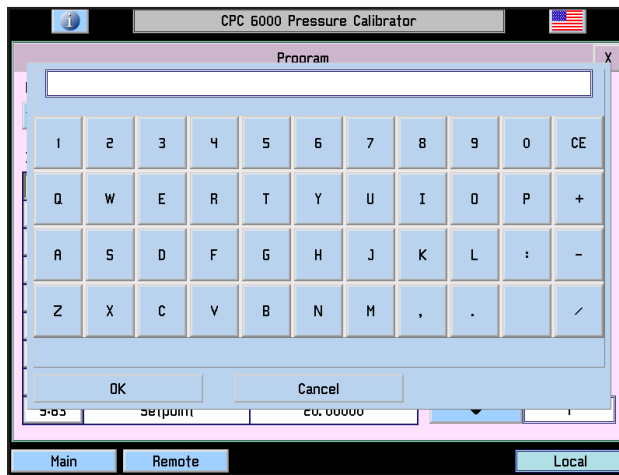

Figure 6.4.1B - Keyboard Screen

The Program Line Edit Screen (Figure 6.4.1C) sets the function of each program line. Each program line performs the function selected from the ones displayed in the left-most column.

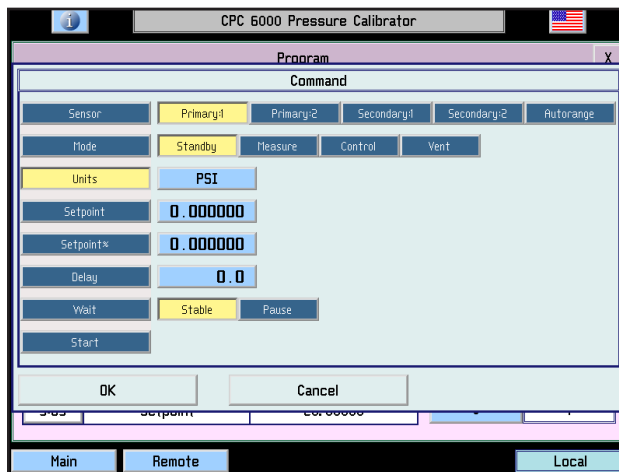

Figure 6.4.1C - Program Line Edit Screen

[Sensor] key: This key selects which sensor and turndown to use for the program.

[Mode] key: The [Mode] key selects the operation mode of the CPC6000.

[Units] key: This key selects the pressure units.

[Setpoint] key: This key allows the control pressure to be set with the key just to its right. Because of the flexibility of the CPC6000, it should be noted that to make the CPC6000 control at this setpoint there needs to be another program line that puts the CPC6000 into the control mode.

[Setpoint%] key: The [Setpoint%] key sets the control pressure at the entered percentage of the range of the currently active transducer.

[Delay] key: The [Delay] key delays the execution of the program for the entered number of seconds.

[Wait] key: The [Wait] key delays the execution of the program until the instrument measures a stable pressure, or the control pressure stabilizes within the control parameters or pauses until the operator presses a key to continue the program execution.

[Start] key: The [Start] key causes execution of the program to begin at the first program line. This is useful for running a program repeatedly until the stop key (the key with the black filled square) is pressed by the operator.

6.4.2 Running a Program

To run a stored program, select the program mode from the channel setup screen (see “6.6.1 - [Channel] Setup”). The main operation screen looks like Figure 6.4.2.

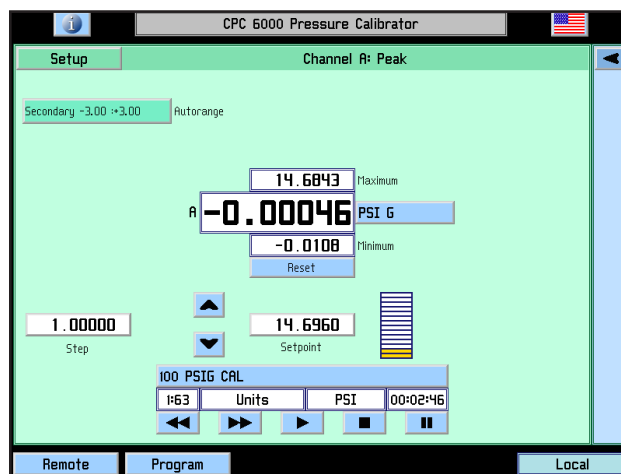

Figure 6.4.2 - Main Operating Screen in Program Mode

At the bottom of the screen, the function tabs (Measure, Control and Vent) are replaced by information and tabs pertaining to the selected program. The large key at the top of this section is the program name. Any saved program may be selected directly from this screen by pressing this key and selecting the program to run.

When a program has been selected, the line below the program name key shows the current program line that is or will be executed. The rightmost box on this line shows the time at which the program has been on the current program line.

The five keys below this control the operation of the program.

The [◀◀] key steps one command line back.

The [▶▶] key steps one command line forward.

The [▶] key begins execution of the program at the first program line. It is also used to re-start a program at the current line after a wait/pause program line.

The next key shows a black square. Pressing this key stops execution of the program and resets the program to the first program line.

The [||] key pauses program execution at the current program line. If the [▶] key is subsequently pressed, the program begins execution at the next program line.

6.5 [Local] Label

On the bottom right of the operation screen (Figure 6.3B) is a 'Local' label to indicate that an RS-232, ethernet, or IEEE-488 host is not trying to control the instrument at this time. The text of this label will change to "Serial", the IP address of the controller, or "GPIB" when the CPC6000 receives a remote command.

6.6 [Setup] Key

Touch the [Setup] tab on the top left or top right corner of the Operation screen (Figure 6.3B) and a new display appears with another set of tabs across the top as shown in Figure 6.6.1A. These tabs are labeled [Channel], [Sensor], and [Controller]. The tab and screen that was last accessed is active by default. The top tabs are used to set up conditions for the related feature/ function as explained in the following text.

6.6.1 [Channel] Setup

Press the [Channel] tab to access the Channel Setup page as shown in Figure 6.6.1A. From there the user can select the optional display function to be [Pressure], which will show only the current reading, or have it show [Peak], [Rate], or [Barometer] readings.

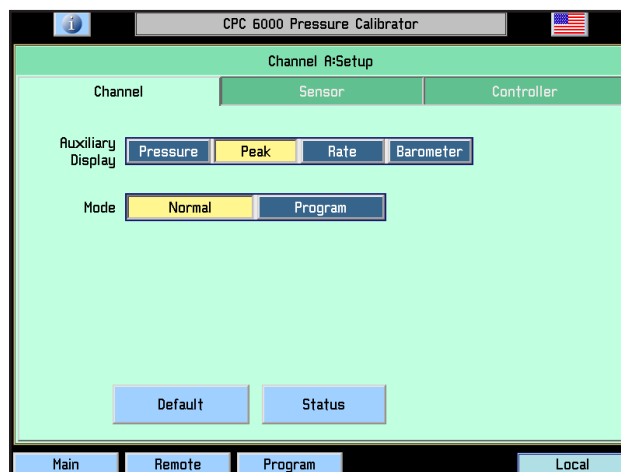

Figure 6.6.1A - Channel Setup Screen

The content of the three active displays are:

[Pressure]: Shows no alternate readings on the screen, only the measured pressure reading.

[Peak]: Displays the highest and lowest pressure points since the last [Reset], or power up. Figure 6.3B shows an example of the Peak feature displayed in this window.

[Rate]: Reports the rate at which the measured pressure is changing in units/second.

[Barometer]: If this optional feature was ordered with your CPC6000, press this key to display the atmospheric pressure reading.

[Normal] (mode selection): This mode will allow the user to command the instrument to individual setpoints manually or remotely.

[Program] (mode selection): This mode will allow the user to define and run user entered program sequences (Figure 6.4B).

[Default]: Touch this key to immediately reset the instrument to the following conditions:

- Autorange ON; a solenoid valve regulator module defaults to low overshoot mode (see 6.6.2 “[Sensor] Setup”).
- Step value: Ignore if valid; Set to 1 if out of range
- Setpoint: Ignore if valid; Set to 0 if out of range
- Restart peak maximum and peak minimum
- Set sensor filter to Normal
- Set control rate to Maximum
- Set maximum allowable control point to match the highest maximum turndown in the instrument
- Set minimum allowable control point equal the lowest minimum turndown in the instrument
- Set the stable window to 0.003% FS
- Set the stable delay to 4 seconds.
- Any existing conditions not covered above will be unaffected.

[Status]: Touch this key to display all current channel information including: Model, Software Version, Serial Number, Range, and Units. See Figure 6.6.1B.

Controller Data	
Model	PUMP
Software Version	1.02
Serial Number	630780
Range	15.0000
Units	PSI

Sensor Data			
Location	Primary	Secondary	Barometer
Vendor	MENSOR	MENSOR	MENSOR
Model	6005NSR	6005NSR	600_BARD
Software Version	3.02	3.02	1.05
Serial Number	832882	832883	680789
Range 1	-15.0000: 15.0000	-3.0000: 3.00000	8.00000: 17.0000
Range 2			
Units	PSI	PSI	PSI
Type	Gauge	Gauge	Absolute
Accuracy	0.010% FS	0.010% FS	0.010% R
Checksum	fffffff	fffffff	00000000

Figure 6.6.1B - Status Screen

6.6.2 [Sensor] Setup

Touch the [Sensor] tab and Figure 6.6.2A will appear.

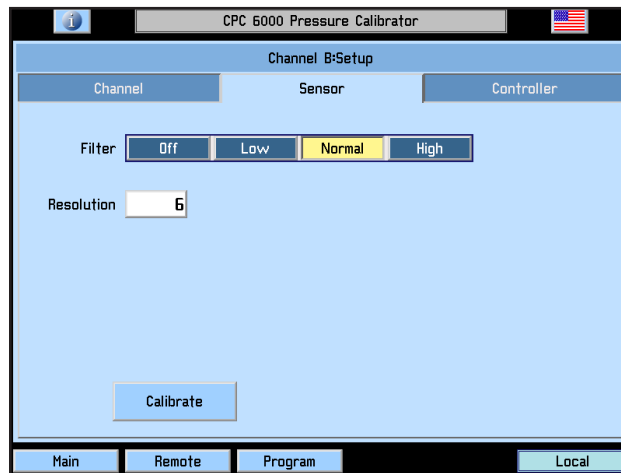

Figure 6.6.2A - Sensor Setup Screen

Filter: The Filter is an electronic filter to smooth out the pressure readings. Because of the differences in resolution, more filtering may display a more stable reading for some pressure units. Select the best filter for the current units. [Off], [Low], [Normal], [High].

Resolution: The Resolution [value] key allows the user to enter the number of significant digits that will be displayed on the operate screen. See Figure 6.6.2B.

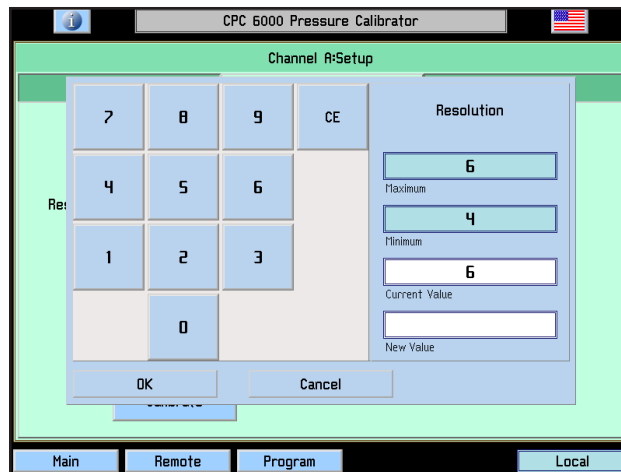

Figure 6.6.2B - Resolution Window

[Calibrate] Setup key: Details for the [Calibrate] key are given in [Section 10](#), Calibration.

6.6.3 [Controller] Setup

The controller setup screen (Figure 6.7.1A for the pump regulator or Figure 6.8 for the solenoid valve regulator) is used to set the control parameters for the selected pressure control channel.

The controller test screens are an interactive diagnostic display used for troubleshooting the overall pneumatic system of the CPC6000. Proper use of these features are described in [Section 9](#), Maintenance.

6.7 Pump Regulator

Control Limits: The control limits cannot be set outside the maximum or minimum ranges of the transducers installed on the active channel. To change a limit touch either of the [Limit Value] keys and enter the new value.

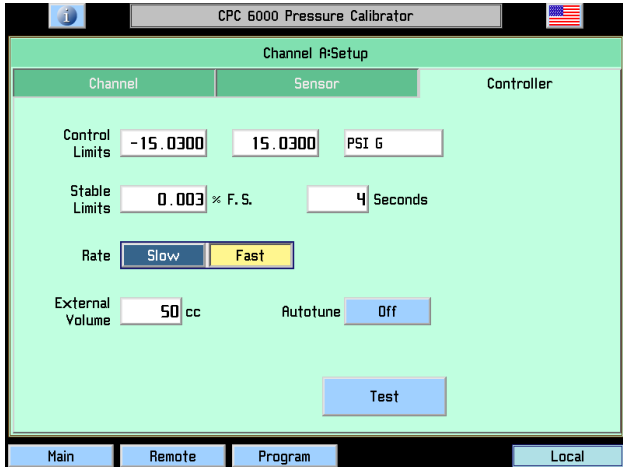

Figure 6.7.1A - Controller Setup, Pump Regulator

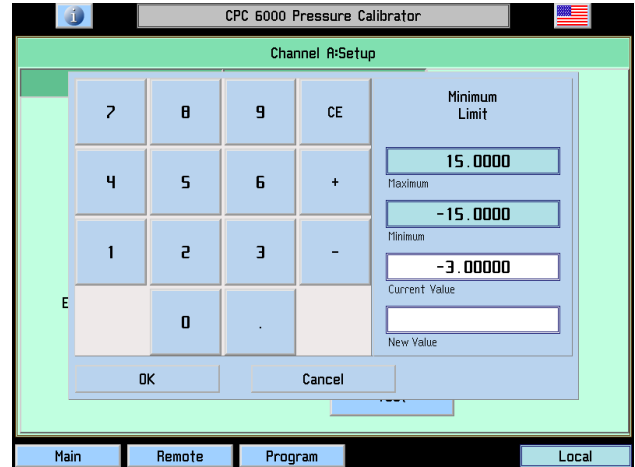

Figure 6.7.1B - Control Limits Window

Stable Limits: The stable limit is the percent of span of the active range that the current pressure can deviate from the setpoint and still display a stable flag.

To change the stable limit or stable delay press the appropriate key. The pop-up number pad will show the upper and lower limits for the item being edited.

Stable Delay: The stable delay is the number of seconds that the instrument must remain within the stable window before the stable flag is displayed.

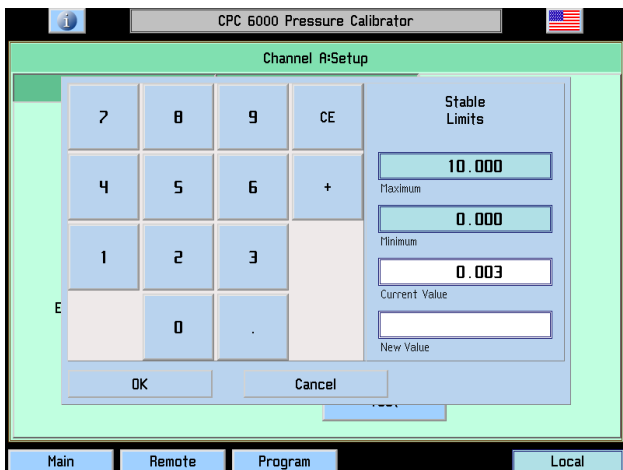

Figure 6.7.1C - Stable Limit Window

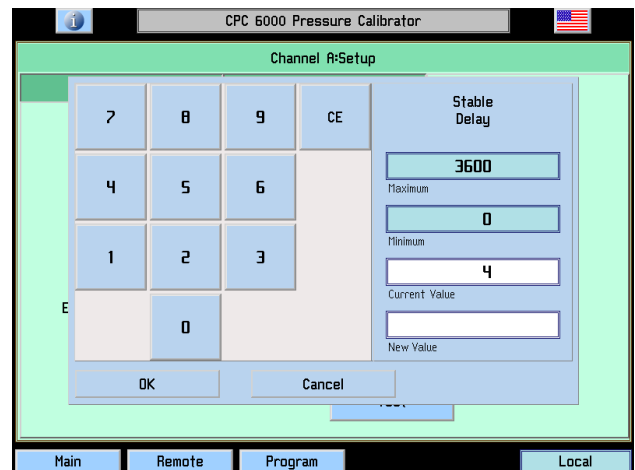

Figure 6.7.1D - Stable Delay Window

Rate: A rate (slewing speed) which best suits the user’s test requirements is selected here. The [Slow] rate will use internal pressure generation without the use of the roughing supply and exhaust valves. Use this mode if no external supply or exhaust pressures are applied to the selected pressure control channel. The [Fast] rate utilizes the roughing supply and exhaust valves.

External Volume: If the autotune is turned on, the external volume of the controlled system is calculated automatically for optimum control performance. If the external volume is known, the user can press the external volume key and enter the volume. Subsequently, if [Autotune] is turned off, the control channel will not re-calculate the external volume on each control setpoint change which will decrease the control times.

Autotune: If the autotune key is turned on, the control channel automatically calculates the external system volume for optimum performance on each control setpoint change. This feature will only operate properly within control specifications after a pressure cycle from minimum to maximum then back to minimum pressure of the primary sensor, and if the maximum span of the primary sensor is greater than 1 psi. In all cases, if the external volume size is known and unchanging, the value should be set and the autotune feature disabled.

[Test] key: is used to enter a test mode that gives the user individual control of all solenoids. This is further described in [Section 9](#), Maintenance.

6.8 Solenoid Valve Regulator

Control Limits: The control limits cannot be set outside the maximum or minimum ranges of the transducers installed on the active channel. To change a limit touch either of the [Limit Value] keys and enter the new value.

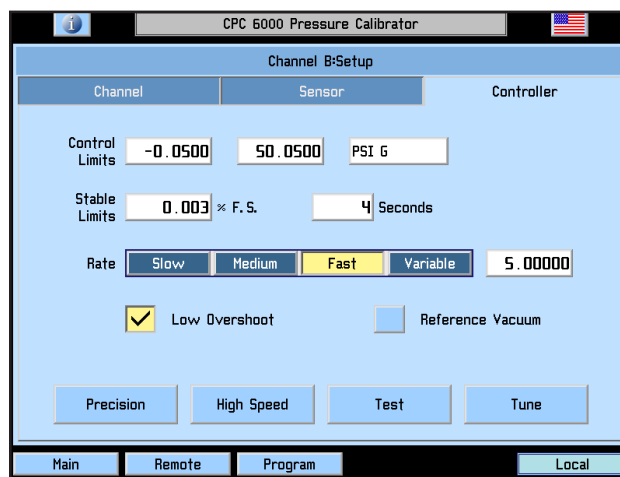

Figure 6.8 - Controller Setup, Solenoid Valve Regulator

Stable Limits: The stable limit is the percent of span of the active range that the instrument can deviate from the setpoint and still display a stable flag. To change the stable limit or stable delay press the appropriate key. The pop-up number pad will show the upper and lower limits for the item being edited.

Stable Delay: The stable delay is the number of seconds that the instrument must remain within the stable window before the stable flag is displayed.

Rate: A rate (slewing speed) which best suits the user's test requirements are selected here. The rates vary the pressure slew rate while driving to a pressure setpoint. The [Slow] rate will target approximately .1% of the highest installed range/second. The [Medium] rate will target approximately 1% of the highest installed range/second. The [Fast] rate will target approximately 10% of the highest installed range/second.

Variable rate allows the customer to enter the desired rate that the controller will approximate in the current units/second.

Low Overshoot check: If this is checked, the control channel will minimize pressure overshoot when driving to a new control setpoint.

Reference Vacuum check: ONLY AVAILABLE ON GAUGE UNITS! If checked, customers may pump the reference port to achieve absolute emulation.

[Precision] key: If this key is selected, parameters are loaded into the active channel so that it will operate with minimum overshoot and maximum stability. This changes the control stable window to 0.003% of the active sensor turndown and the stable delay to 4 seconds.

High Speed] key: If this key is selected, parameters are loaded into the active channel so that it will operate in a high control speed mode. This changes the control stable window to 0.006% of the active sensor turndown and the stable delay to 1 second. It also changes the way the controlled pressure approaches the setpoint to minimize the time to stable.

[Test] key: This key is used to enter a test mode that gives the user individual control of all solenoids. This is further described in [Section 9](#), Maintenance.

[Tune] key: This key is used to tune the regulator. This is described further in [Section 9](#), Maintenance.

7. Remote Operation

7.1 Remote Setup

Use the following screens to set the operating parameters for the Ethernet, RS-232 serial port, and IEEE-488.

Press the [Remote] key located on the bottom left corner of the screen, and a new display appears with another set of tabs across the top as shown in Figure 7.1.1.

7.1.1 [Instrument] Setup Screen

Press the [Instrument] tab to set up available emulation modes. The default command set is Mentor.

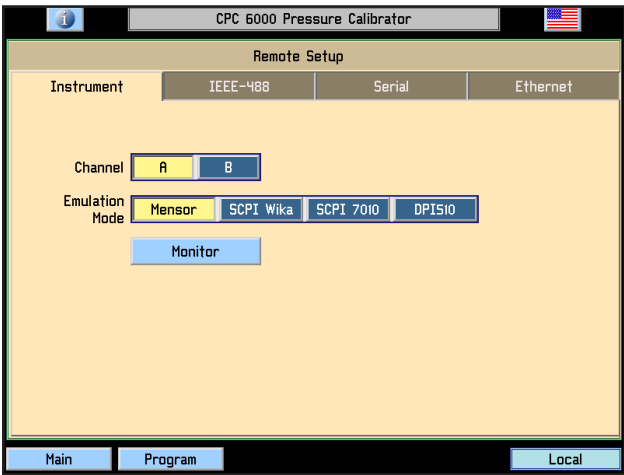

Figure 7.1.1A - [Instrument] Setup Screen

[A] [B] (channel selection): This channel selection sets the active remote channel to A or B and is useful for customers using an CPC6000 to replace two single channel controllers. The user can simply select the channel here first and then begin their normal program.

[Monitor] key: Press the [Monitor] key to bring up the remote monitor window which displays current remote activity and syntax errors. This is helpful when troubleshooting programs.

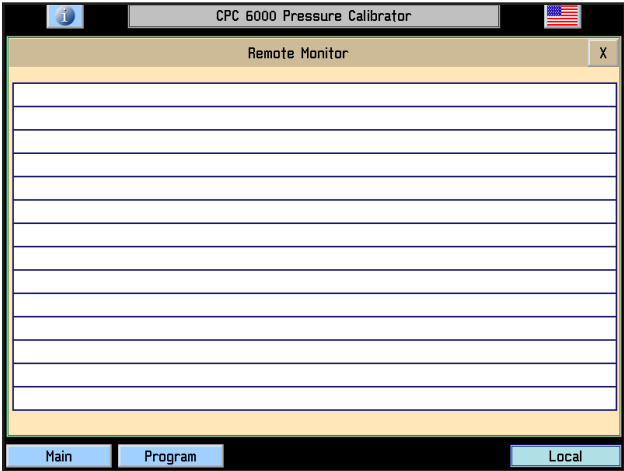

Figure 7.1.1B - Monitor Window

7.1.2 [IEEE-488] Setup Screen

Press the [IEEE-488] tab to set up the IEEE address. Press the white box and a number keypad will appear for you to enter your new IEEE address and then press [OK].

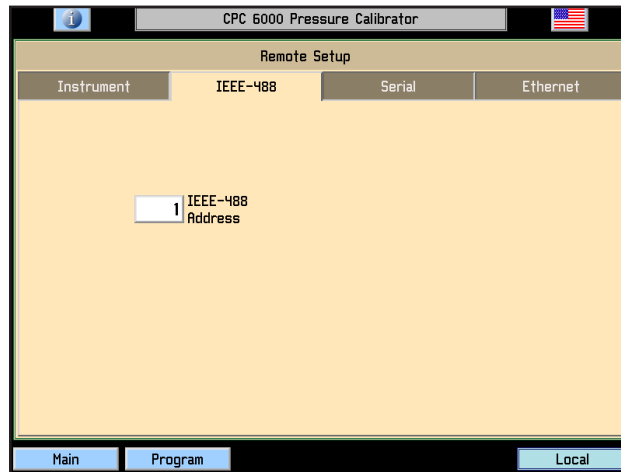

Figure 7.1.2 - [IEEE-488] Setup Screen

7.1.3 [Serial] Setup Screen

Press the [Serial] tab to set up the serial port parameters. These parameters should be set up to match your host computer. Default settings are: 57600, 8,1, none parity, and no echo.

If the Echo check box is checked, the CPC6000 will immediately echo back characters sent over the serial port.

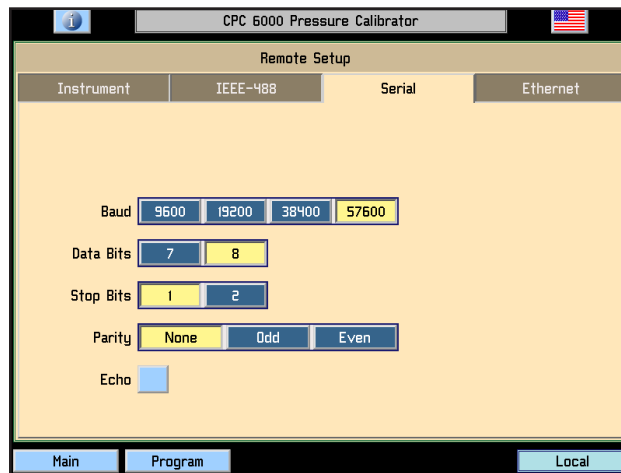

Figure 7.1.3 - [Serial] Setup Screen

7.1.4 [Ethernet] Setup Screen

Press the [Ethernet] tab to set up the Ethernet parameters. These parameters should be set up to match your host computer.

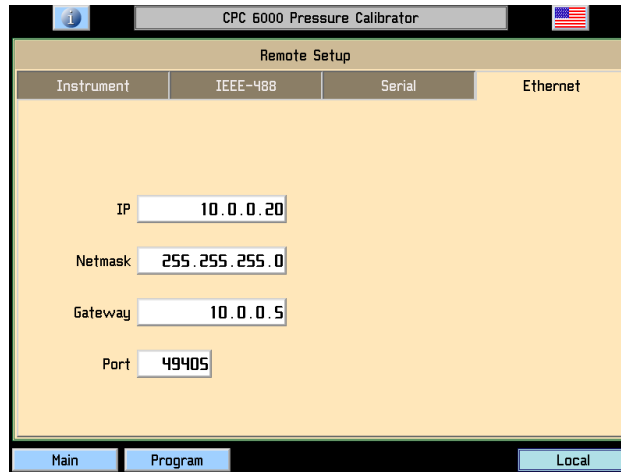

Figure 7.1.4 - [Ethernet] Setup Screen

When the correct values have been selected for all four parameters simply touch any of the keys across the top or the bottom of the screen or the [X] key on the upper right of the window to move on to another function. Emulation modes are also available for legacy instrument replacement. Contact Mensor for availability.

7.2 Ethernet Communication

The ethernet communication port allows the CPC6000 to communicate with computers using 10/100Based-T specifications.



Caution

CAUTION: Please consult your Computer Resources Department prior to connecting this instrument to your network to verify there are no conflicts with existing IP addresses.

Ethernet communications are transmitted over a standard RJ-45 cable.

Connecting directly to a PC requires a crossover ethernet cable. Hub connection requires a straight ethernet cable.

Prior to first time use of ethernet communication, the four parameters, IP, Netmask, Gateway, and Port must be setup. These are set up in the Remote setup screen.

7.3 IEEE-488 (GPIB)

The manufacturer of the host IEEE-488 interface board provides software to allow communication between the board and various programming languages. An interactive program for debugging is usually provided as well. Refer to the board manufacturer's documentation for more information.

7.3.1 Capability Codes

SH1	Full source handshake capability
AH1	Full acceptor handshake capability
T6	Talker with serial poll and unaddress if MLA
L4	Listener with unaddress if MTA
SR1	Full service request capability
RL1	Full remote/local capability including LLO
PP0	No parallel poll capability
DC1	Full device clear capability
DT1	Full device trigger capability
C0	No controller capability
E2	Tri-state outputs

7.3.2 Interface Functions

The CPC6000 responds to the following IEEE-488 interface functions:

SRQ	Service Request: A service request is asserted whenever an error is encountered. When the bus controller issues a serial poll the error will be cleared. If the host IEEE board includes automatic serial polling capability, turn this feature off in order to view all errors (see ERROR? command).
LLO	Local Lockout: The front panel keyboard of the CPC6000 may be locked by sending LLO or the command LOCK ON.
GET	Group Execute Trigger: When this message is received, the CPC6000 will save the current readings until the next time it is addressed as a talker.
GTL	Go To Local: A GTL message will cause the CPC6000 return to local operation and unlock the keyboard.
DCL	Device Clear: When this message is received, the CPC6000 will clear all errors and buffers and remain in the REMOTE mode.
SDC	Selected Device Clear: The effect is the same as DCL.
EOI	End or Identify: May be used as a command or query terminator in the place of, or concurrent with, a terminating linefeed.

7.4 RS-232 Serial Communication

The serial communication port allows the CPC6000 to communicate in RS-232 format with computers, terminals, PDAs, or similar hosts.

7.4.1 Cable Requirements

RS-232 communications are transmitted over a three conductor, shielded cable terminated in a standard DB9S connector on the instrument end, and usually the same connector on the host end. Figure 7.4.1 illustrates the proper pin-outs. Notice that each pin 2 is connected to pin 3 on the opposite end. This configuration is commonly referred to as a 9-pin null modem cable.

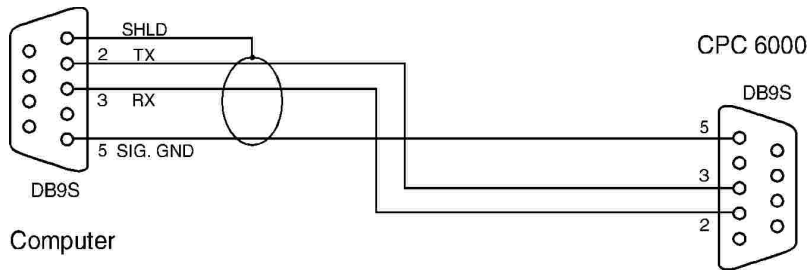

Figure 7.4.1 - Serial Cable

7.4.2 Command and Query Format

Commands must be sent in ASCII format and terminated with either a carriage return (<cr>), linefeed (<lf>) or both. Commands are not case sensitive. Each query returns a response. If an error is detected the response will include an error flag.

One of the first commands issued when starting remote communications should be “Keylock Yes”. This will disable the on-screen keys and tabs, and place the “Keylock” label on the screen. Turning keylock on prevents the potential conflicts that could occur if someone pressed an on-screen key, either intentionally or by accident.

Command/Query Field: Unless otherwise specified, commands are typically converted to queries by appending a question mark to the command. Table 7.5.1 lists all of the CPC6000 command/query keywords.

Data Field: The data field is either in ASCII {string} or numeric {value} form. In the case of multiple data fields, commas are required to separate the fields. Queries do not have a data field. String (text) or value (numeric) data are acceptable in any of the following formats:

Examples of {string} data:	ON	OFF	mBar	inHg
Examples of {value} data:	1	1.0	-5.678	25.68324e-5

7.4.3 Command Set Definitions

In this manual a data entry made up of alpha characters is defined as a string, as opposed to data containing only numbers, such as “Enter 1 for ON or 0 for OFF” where 1 and 0 are defined as values.

Command: Any command or query listed in Table 7.5.1.

Separator: Space (SP).

Data: ASCII representations of numbers, {value}, or alpha characters, {string}, data as defined above. When sending code a literal variable replaces the braces and the enclosed character(s) shown in the following examples.

Termination: Linefeed (LF) or carriage return (CR) is used to signal the end of a command statement. For IEEE-488 operation “EOI” is an acceptable alternative.

Always send commands in one of the following formats:

1. [Command] [Termination];
2. [Command] [Separator] [Data] [Termination];
3. Queries are special instructions in the form:
[Command?] [Termination] where the question mark, "?", immediately precedes the terminator.

When a valid query is received, the CPC6000 will return {data} terminated by CR and LF.

Floating point data is returned in the current engineering units in exponential format.

7.4.4 Output Formats

Pressure readings are returned in exponential notation in a format according to the OUTFORM command as follows:

1. <sp> pressure value <cr><lf>
2. <sp> pressure, units number, mode <cr><lf>
3. <sp> pressure, pressure rate <cr><lf>
4. <sp> pressure, minimum peak, maximum peak<cr><lf>
5. <sp> pressure, active sensor (P or S), active turndown (1-4)<cr><lf>
6. <sp> pressure, control point, "stable" or "slewing"<cr><lf>
7. <sp> pressure, "no barometer" or baro reading <cr><lf>

The space <sp> at the beginning of the string is replaced with an "E" if the CPC6000 has detected a remote communication error.

For commands that take boolean data the following strings are acceptable:

0	1
False	True
No	Yes
Off	On

7.5 CPC6000 Command Set

7.5.1 CPC6000 Commands and Queries

Table 7.5.1 lists all of the current CPC6000 specific commands and queries.



**Channel specific commands are sent to only the active channel.
See 'CHAN' command.**

Notice

Optional emulation modes are available in which the CPC6000 can emulate remote functions of different brands of pressure controllers. The Ruska 7010 and Ruska 7250 controllers may be emulated by enabling the SCPI 7010 command set. Please contact Mensor for more details.

Table 7.5.1 - CPC6000 Commands and Queries

Ref	Command	Data	Function/Response
1	?	See "Output Format" text	Returns data per the current output format.
2	Acquire?	{15 char string} Returns: <sp>(YES or NO),{string}<cr><lf>	This command is used when multiple computers would like to control the instrument. Yes if acquisition is successful, No if instrument is being controlled with another computer. The string is an identifier for the controlling computer. See: Release? And Unlock.
3	Address	{1 to 31}	Sets the GPIB Address.
4	Address?	<sp>{value}<cr><lf>	Returns the GPIB Address within 1 to 30.
5	A?	<sp>{value}<cr><lf>	Returns the A channel pressure reading.
6	AR?	<sp>{value}<cr><lf>	Returns the A channel rate.
7	ARS?	<sp>{YES or NO}<cr><lf>	Returns the A channel rate stable flag.
8	AS?	<sp>{YES or NO}<cr><lf>	Returns the A channel stable flag.
9	Autorange	{ON or OFF}	Toggles autorange function to its opposite state, either ON or OFF (enabled or disabled).
10	Autorange?	<sp>{ON or OFF}<cr><lf>	Returns whether the autorange function is enabled or disabled.
11	Autozero	none	Re-zero all ranges that can measure the vented pressure. These adjustments are not password protected and are not saved through power cycles. This command takes approximately 60 seconds.
12	Autozero?	S,T,X,X	Returns autozero data where S represents state (responses can be 0 = complete, 1 = local autozero, or 2 = remote autozero), T represents the estimated remaining time to complete in seconds, and X is a (0) character since this data location is not used at this time.
13	Autozeroabort	none	Aborts autozero.
14	Baro?	<sp>{value}<cr><lf>	Returns reading from barometric sensor.
15	B?	<sp>{value}<cr><lf>	Returns the B channel pressure reading.
16	BR?	<sp>{value}<cr><lf>	Returns the B channel rate.
17	BRS?	<sp>{YES or NO}<cr><lf>	Returns the B channel rate stable flag.

Modular Precision Pressure Controller CPC6000

Ref	Command	Data	Function/Response
18	BS?	<sp>{YES or NO}<cr><lf>	Returns the B channel stable flag.
19	Caldisable	{YES or NO}	Disables the zero and span commands (default = YES). When the cal-disable is YES, the zero and span commands are disabled.
20	Caldisable?	<sp>{YES or NO}<cr><lf>	Returns whether or not calibration of the active sensor is disabled.
21	Cerr	none	Clears the error queue.
22	Chan	{A or B}	Sets the active channel on the instrument.
23	Chan?	<sp>{A or B}<cr><lf>	Returns which channel is active.
24	Chan D	none	Sets the active channel to the Differential channel.
25	Chanfunc	{Press,peak,rate,baro}	Sets the alternate function mode of the active channel.
26	Chanfunc?	<sp>{string}<cr><lf>	Returns the alternate function mode of the channel.
27	Control	none	Instrument placed in Control mode.
28	Control?	<sp>{YES or NO}<cr><lf>	Returns YES if active channel is in Control mode; NO if otherwise.
29	Crate	{Slow, Medium, Fast, Variable} for mid or high range regulator, {Slow or Fast} for low range regulator.	Sets the control slew rate for the current channel. For Variable rate see: Rsetpt command.
30	Crate?	<sp>{string}<cr><lf>	Returns the current rate - value corresponds to the parameters for the CRATE command.
31	Decpt?	<sp>{value}<cr><lf>	Returns the number of significant digits to the right of the decimal point.
32	Default	none	Sets the default values. This command takes approximately 20 seconds.
33	Deltafunc A-B	none	Sets the delta to be the result of the channel A reading – channel B reading. Note: Chan D must be the active channel.
34	Deltafunc B-A	none	Sets the delta to be the result of the channel B reading – channel A reading. Note: Chan D must be the active channel.
35	Deltafunc?	<sp>{A-B or B-A}<cr><lf>	Returns delta function as one of the above options. Note: Chan D must be the active channel.
36	DIO	{0 or 2}	0 turns the digital IO output pin off or low. 2 turns the digital IO output pin on or high.
37	DIO?	{value}	0 if input is low and output is low. 1 if input is high and output is low. 2 if input is low and output is high. 3 if input is high and output is high.
38	DOC	<mm/dd/yyyy>	Sets the date of cal for the active sensor and turndown.
39	DOC?	<sp>{mm/dd/yy}<cr><lf>	Returns the date of cal for the active sensor and turndown.
40	DOM?	<sp>{mm/dd/yyyy}<cr><lf>	Returns the date of manufacture.
41	Error?	<sp>{string}<cr><lf>	Returns a description of an error.

Ref	Command	Data	Function/Response
42	Errorno?	<sp>{string}<cr><lf>	Returns CPC6000 error code and text.
43	Filter	{Off, Low, Normal, High}	Sets the reading filter.
44	Filter?	<sp>{string}<cr><lf>	Returns the reading filter.
45	Gasdensity	{value}	Sets the head pressure gas density in lb/ft^3.
46	Gasdensity?	<sp>{value}<cr><lf>	Returns the head pressure gas density in lb/ft^3.
47	Gastemp	{value}	Sets the head pressure gas temperature in °F.
48	Gastemp?	<sp>{value}<cr><lf>	Returns the head pressure gas temperature.
49	Gateway	{string e.g. nnn.nnn.nnn.nnn}	Sets the Ethernet gateway address.
50	Gateway?	<sp>{string}<cr><lf>	Returns the Ethernet gateway address.
51	Height	{value}	Sets the head pressure height in inches.
52	Height?	<sp>{value}<cr><lf>	Returns the head pressure height.
53	Highspeed	{Yes or No}	Sets the active channel to high speed mode: .006% stablewindow and 1 second stabledelay.
54	ID?	<sp>MENSOR,600,{ssssss},{v.vv}<cr><lf>	Returns the instrument identity where {ssssss} is the serial number and {v.vv} is the software version number.
55	IP	{string e.g. nnn.nnn.nnn.nnn}	Sets the IP address of the instrument.
56	IP?	<sp>{string}<cr><lf>	Returns the IP address of the instrument.
57	Keylock	{Yes or No}	YES to lock, or NO to unlock the on-screen keys.
58	Keylock?	<sp>{Yes or No}<cr><lf>	Returns current keylock status as YES or NO.
59	List?	<sp>Pri,X,X;Sec,X,X;Bar,1<cr><lf>	Returns list of available turndowns on installed sensors in the active channel. X will be non-existent if the turndown is not available.
60	Listcal?	<sp>PRI,{sn},{td},{mm/dd/yyyy},{td},{mm/dd/yyyy};SEC,{td},{mm/dd/yyyy},{td},{mm/dd/yyyy}<cr> <lf>	Returns the serial number of each installed transducer and calibration dates for each range.
61	Listrange?	<sp>PRI,{td},{min},{max},{td},{min},{max};SEC,{td},{min},{max},{td},{min},{max}<cr><lf>	Returns the minimum and maximum ranges of all installed sensors for the active channel.

Ref	Command	Data	Function/Response		
62	Locale	{locale code}	Sets Language and Country code.		
			<p>Locale Code</p> en_us en_ca en_gb fr_fr fr_ca es_es es_mx de_de it_it zh_cn ko_ko ru_ru de_ch fr_ch en_ie ja_jp pl_pl pt_pt	<p>Language</p> english english english french french spanish spanish german italian chinese korean russian german french english japanese polish portuguese	<p>Country</p> usa canada great brittain france canada spain mexico germany italy china korea russia switzerland switzerland ireland japan poland portugal, brazil
63	Locale?	<sp>{string}<cr><lf>	Returns current language and Country locale.		
64	Localgravity	{value}	Sets the acceleration of gravity in feet/sec^2.		
65	Localgravity?	<sp>{value}<cr><lf>	Returns the local gravity in feet/sec^2.		
66	LowerLimit	Value inside primary transducer range on turndown #1 in current units.	Sets the lower control limit for the active channel.		
67	LowerLimit?	<sp>{value}<cr><lf>	Returns the lower control limit for the active channel.		
68	Lowovershoot	{Yes or No}	Sets the active channel to low overshoot mode.		
69	Lowovershoot?	<sp>{Yes or No}<cr><lf>	Returns the current setting of the lowovershoot mode.		
70	Measure	none	Instrument placed in Measure mode.		
71	Measure?	<sp>{Yes or No}<cr><lf>	Returns YES if active channel is in Measure mode; NO if otherwise.		
72	Mode	{standby, measure, control, vent}	Sets the operation mode of the active channel.		
73	Mode?	<sp>{string}<cr><lf>	Returns the operation mode of the active channel.		
74	Netmask	{nnn.nnn.nnn.nnn}	Sets the Ethernet network mask.		
75	Netmask?	<sp>{nnn.nnn.nnn.nnn}<cr><lf>	Returns the Ethernet network mask.		
76	Outform	{1 to 8}	Sets the output format. See 'Output Formats' in Section 4 , Remote Operation.		
77	Outform?	<sp>{X}<cr><lf>	Returns the current output format.		
78	Peakmax?	<sp>{value}<cr><lf>	Returns the maximum pressure since peakreset was sent.		

Ref	Command	Data	Function/Response
79	Peakmin?	<sp>{value}<cr><lf>	Returns the minimum pressure since peakreset was sent.
80	Peakreset	none	Resets the peak values.
81	Port	{value}	Sets the Ethernet port of the instrument.
82	Port?	<sp>{value}<cr><lf>	Returns the Ethernet port of the instrument.
83	Precision	none	Sets the active channel to the precision mode: .003% stablewindow and 4 second stabledelay.
84	Ptype	{Absolute or Gauge or A or G}	Sets the instrument pressure type – non-native type only works if the optional barometric sensor is installed.
85	Ptype?	<sp>{Absolute orGauge}<cr><lf>	Returns “Absolute” or “Gauge” for the pressure type.
86	RangeMax?	<sp>{value}<cr><lf>	Returns the maximum range of the active transducer and turndown in the current units.
87	RangeMin?	<sp>{value}<cr><lf>	Returns the minimum range of the active transducer and turndown in the current units.
88	Rate?	<sp>{value}<cr><lf>	Returns the rate reading of the instrument in current units/second.
89	Rdecpt?	<sp>{value}<cr><lf>	Returns the number of rate decimal points for the active channel. See: Resolution
90	Reference	{EXTVAC or ATM}	Sets the reference type for vacuum pump connected to the reference, or vented to atmosphere. This option is only available on native gauge units.
91	Reference?	<sp>{EXTVAC or ATM}<cr><lf>	Returns the current reference type of the active channel. See: Reference
92	Release?	{15 char string}	Returns: <sp>(YES or NO), {string}<cr><lf> This command is used to release control of the instrument when it is accessed by more than one computer. To release control of the instrument, {string} must be identifier used for the “Acquire” command. Yes if release is successful. No if instrument is being controlled with another computer. Return {string} = identifier of the controlling computer or AVAILABLE. See: Acquire? and Unlock.
93	Repeat	None	Repeats output continually over serial port only.
94	Resolution	{4 to 6}	Sets the number of significant digits. See: decpt
95	Resolution?	<sp>{value}<cr><lf>	Returns the number of significant digits.
96	Rsetpt	{value}	Sets the rate setpoint of the active channel in current units per second. Must be a value inside the current sensor range.
97	Rsetpt?	<sp>{value}<cr><lf>	Returns the current rate setpoint of the active channel in current units per second.
98	Sbaud	{9600, 19200, 38400, 57600}	Sets the serial baud rate.
99	Sbaud?	<sp>{value}<cr><lf>	Returns the serial baud rate.
100	Screensrc A,B	None	Sets the CPC6000 to normal operation screen displaying A and B channels.

Ref	Command	Data	Function/Response
101	Screensrc A,Delta	None	Sets the CPC6000 to display A channel as normal, and Delta channel replaces the B channel location. In this mode the “A” channel is considered the leading channel.
102	Screensrc Delta,B	None	Sets the CPC6000 to display B channel as normal, and Delta channel replaces the A channel location. In this mode the “B” channel is considered the leading channel.
103	Screensrc?	<sp>{A,B or A,Delta or Delta,B}<cr><lf>	Returns screen source as one of the above options.
104	Sdata	{7 or 8}	Sets the serial data bits.
105	Sdata?	<sp>{value}<cr><lf>	Returns the serial data bits number.
106	Sensor	C, X	Sets the active sensor where C = Primary or Secondary and X is the turndown.
107	Sensor?	<sp>{C,X}<cr><lf>	Returns the active sensor as above.
108	Sensor.acc?	<sp>{value}<cr><lf>	Returns the accuracy of the sensor.
109	Sensorid?	<sp>{Address}<sp>MENSOR ,<sp>600SNSR,<sp>{Serial No.},V{V.VV}<cr><lf>	Returns the active sensor’s serial number and firmware version.
110	Setpt	{A value inside the upper/lower limits, and inside the range of the active transducer and turndown}	Sets the control setpoint for the active channel.
111	Setpt?	<sp>{value}<cr><lf>	Returns the control setpoint of the active channel in current units.
112	Span	{desired pressure or ?}	Sets span on active transducer (must be >50% FS, and within 1% limit), or ? to clear previous value. See “Caldisable” command above ref #19
113	Span?	<sp>{value}<cr><lf>	Returns span scale factor for active transducer and turndown.
114	Sparity	{Even, ODD , NONE}	Sets the serial parity.
115	Sparity?	{<sp>{string}<cr><lf>	Returns the serial parity.
116	Srqmask	Stable, Error or both	Sets the CPC6000 to issue a service request (SRQ) over the IEEE-488 when the pressure control is stable, or an error occurs. These are 80 hex and 40 hex respectively.
117	Srqmask?	<sp>{string}<cr><lf>	Returns “stable”, “error” or “error, stable” depending on the SRQ.
118	Sstop	{1 or 2}	Sets the serial stop bits.
119	Sstop?	<sp>{value}<cr><lf>	Returns the serial stop bits.
120	Stable?	<sp>{Yes or No}<cr><lf>	Returns YES if instrument is stable or NO.
121	Stabledelay	{0 to 65535}	Sets the stable time to the number of seconds specified.
122	Stabledelay?	<sp>{value}<cr><lf>	Returns the stable time.
123	Stabletime	{0 to 65535}	Sets the stable time to the number of seconds specified.

Ref	Command	Data	Function/Response
124	Stabletime?	<sp>{value}<cr><lf>	Returns the stable time.
125	StableWin	{%fs value}	Sets the stable window as a %FS.
126	StableWin?	<sp>{value}<cr><lf>	Returns the stable window in % of Span.
127	Standby	none	Instrument placed in Standby mode, all solenoids de-energized.
128	Standby?	<sp>{Yes or No}<cr><lf>	Returns YES if the active channel is in Standby, NO if otherwise.
129	Step	<sp>{value inside upper and lower limits and inside the range of the active sensor and turndown}<cr><lf>	Sets the control step size for the instrument.
130	Step-	{none or value}	Jogs the setpoint down one step. If a value is entered, sets the step size to that value.
131	Step+	{none or value}	Jogs the setpoint up one step. If a value is entered, sets the step size to that value.
132	Step?	<sp>{value}<cr><lf>	Returns the control step for the instrument.
133	Stop	none	Stop repeating output over serial port. See: Repeat
134	Tare	on/off	Sets the tare function on or off, Delta channel only.
135	Tare?	on/off<cr><lf>	Returns whether the tare function is on or off.
136	Units	{units code, or output format text from Measurement Units Table 11.1 in Appendix}	Sets the instrument engineering units.
137	Units?	<sp>{string}<cr><lf>	Returns the instrument units in a text string.
138	Unlock	none	Releases Acquire locks. See: Acquire? and Release?
139	UpperLimit	{Value inside primary transducer range}	Sets the upper control limit for the active channel.
140	UpperLimit?	<sp>{value}<cr><lf>	Returns the upper control limit for the active channel.
141	Vent	none	Instrument placed in Vent mode.
142	Vent?	<sp>{Yes or No}<cr><lf>	Returns YES if active channel is in Vent mode, No if otherwise.
143	Versions?	<sp>{string}<cr><lf>	Returns the versions of the firmware for the instrument, gpib driver, gate array, installer, and the graphics library.
144	Volume	{value in cc}	Sets the system volume in cc's – only applicable if the active channel is a low pressure regulator.
145	Volume?	<sp>{value}<cr><lf>	Returns the current system volume in cc's – only applicable if the active channel is a low pressure regulator.
146	WID?	<sp>MENSOR,CPC6000, 41ssssss,v.v.vv<cr><lf>	The new SN format leads with 41, followed by an alphanumeric string between 6-9 characters long. If the WIKA SN is not implemented, returns "UNDEFINEDWIKASN!" and ID? should be used. See ID? for standard query.
147	Zero	{desired pressure or ?}	Sets active sensor and turndown's zero to entered pressure, or ? to clear previous value. (See "Caldisable" command above ref# 19)
148	Zero?	<sp>{value}<cr><lf>	Returns zero offset value for active sensor and turndown.

7.5.2 CPC6000 Error Codes

Table 7.5.2 - CPC6000 Error Codes

Code	Serial Poll Byte	Description	Error String Returned
E00	00h	reserved	unused code
E01	41h	GPIB listen/talk error	GPIB LISTEN/TALK ERROR
E02	42h	Syntax error	UNKNOWN COMMAND
E03	43h	Expected a valid _PCS4 command	EXPECTED A VALID _PCS4 COMMAND
E04	44h	Expected a valid FUNC command	EXPECTED A VALID FUNC COMMAND
E05	45h	Expected a valid CAL command	EXPECTED A VALID CAL COMMAND
E06	46h	Expected a valid TEST command	EXPECTED A VALID TEST COMMAND
E07	47h	Expected a pressure units selection	EXPECTED A PRESSURE UNITS SELECTION OR INVALID TERMINATION STRING
E08	48h	Expected a pressure value	EXPECTED A PRESSURE VALUE
E09	49h	Expected a transducer selection	EXPECTED A XDUCER SELECTION
E10	4ah	Expected a seconds selection	EXPECTED A SECONDS SELECTION
E11	4bh	reserved	unused code
E12	4ch	reserved	unused code
E13	4dh	Invalid pressure units selection	INVALID PRESSURE UNITS SELECTION
E14	4eh	Invalid control pressure value selection	INVALID CONTROL PRESSURE VALUE SELECTION
E15	4fh	Invalid rate value selection	INVALID RATE VALUE SELECTION
E16	50h	Invalid a/d unit selection	INVALID A/D UNIT SELECTION
E17	51h	Invalid zero offset value selection	INVALID ZERO OFFSET VALUE SELECTION
E18	52h	Invalid Span offset value selection	INVALID SPAN OFFSET VALUE SELECTION
E19	53h	Invalid rate units selection	INVALID RATE UNITS SELECTION
E20	54h	Sensor overrange	SENSOR OVERRANGE
E21	55h	Sensor underrange	SENSOR UNDERRANGE
E22	56h	Sensor failure detected	SENSOR FAILURE DETECTED
E23	57h	Low source pressure	LOW SOURCE PRESSURE
E24	58h	Regulator failure detected	REGULATOR FAILURE DETECTED
E25	59h	reserved	unused code
E26	5ah	Internal leak detected	INTERNAL LEAK DETECTED
E27	5bh	Program error detected	PROGRAM ERROR DETECTED
E28	5ch	Memory error detected	MEMORY/COEFFICIENT ERROR DETECTED
E29	5dh	External Leak detected	EXTERNAL LEAK DETECTED
E30	5eh	High exhaust pressure	VACUUM ERROR DETECTED
E31	5fh	Transducer error detected	XDUCER ERROR DETECTED
E32	60h	Invalid transducer selection	INVALID TRANSDUCER SELECTION

Code	Serial Poll Byte	Description	Error String Returned
E33	61h	Invalid filter window selection	INVALID FILTER WINDOW SELECTION
E34	62h	Invalid filter setting selection	INVALID FILTER SETTING SELECTION
E35	63h	Invalid output format selection	NOT A VALID OUTPUT FORM SELECTION
E36	64h	Invalid stable window selection	INVALID STABLE WINDOW SELECTION
E37	65h	Invalid stable delay selection	INVALID STABLE DELAY SELECTION
E38	66h	reserved	unused code
E39	67h	Expected a filter setting selection	EXPECTED A FILTER SETTING SELECTION
E40	68h	Expected an output format selection	EXPECTED AN OUTPUT FORM SELECTION
E41	69h	Expected a stable delay selection	EXPECTED A STABLE DELAY SELECTION
E42	6ah	Expected a language selection	EXPECTED A LANGUAGE SELECTION
E43	6bh	reserved	unused code
E44	6ch	reserved	unused code
E45	6dh	PCS200 command format error	PCS200 COMMAND FORMAT ERROR
E46	6eh	Control pressure overrange	CONTROL PRESSURE OVERRANGE
E47	6fh	Control pressure underrange	CONTROL PRESSURE UNDERRANGE
E48	70h	Illegal GPIB controller function	ILLEGAL GPIB CONTROLLER FUNCTION
E49	71h	GPIB error	GPIB ERROR
E50	72h	Invalid termination	INVALID TERMINATION
E51	73h	Vent mode disabled	VENT MODE DISABLED
E52	74h	Special functions not available	SPECIAL FUNCTIONS NOT AVAILABLE
E53	75h	reserved	unused code
E54	76h	Expected a valid DPC-179 command	EXPECTED A VALID DPC-179 COMMAND
E55	77h	Expected a valid DPC-179 header command	EXPECTED A VALID DPC-179 HEADER COMMAND
E56	78h	Expected a valid DPC-179 control command	EXPECTED A VALID DPC-179 CONTROL COMMAND
E57	79h	reserved	unused code
E58	7ah	reserved	unused code
E59	7bh	reserved	unused code
E60	7ch	reserved	unused code
E61	7dh	reserved	unused code
E62	7eh	reserved	unused code
E63	7fh	Cal functions disabled	CAL FUNCTIONS DISABLED

7.6 Remote Emulation

The Mensor PCS 400 is an earlier generation instrument similar to the CPC6000. There is some compatibility between the CPC6000 and a PCS 400 in that the CPC6000 will respond to many of the remote instructions as if it were the older instrument. The PCS 400 commands will operate only on the currently active control channel.

Table 7.6.1 is a list of the remote commands and queries which the CPC6000 will recognize and respond to.

A space between elements in a command indicates a required delimiter. Use a space where such a delimiter is indicated. A full description of the syntax and use for each of these commands and queries are presented in the PCS 400 manual.



Notice

All pressure values will be in the currently active pressure units unless otherwise stated.

7.6.1 PCS 400 Emulated Commands and Queries

Table 7.6.1 - PCS 400 Emulated Commands and Queries

Ref	Command	Data	Function / Response
1	_pcs4 autorange <value>	0 or 1	1 turns autorange on, 0 turns autorange off.
2	_pcs4 autorange?		Returns 1 if in autorange, 0 if in range hold.
3	_pcs4 cal span <value>		Sets the span of the active transducer to <value>.
4	_pcs4 cal zero <value>		Sets the zero of the active transducer to <value>.
5	_pcs4 cal_disable_off		Enables zero or span calibrations if previously disabled.
6	_pcs4 cal_disable_on		Prevents zero or span calibrations.
7	_pcs4 ctrl <value>		Sets control value. Will take effect immediately if instrument is in control mode.
8	_pcs4 ctrl?		Returns the current control point in current engineering units.
9	_pcs4 ctrlmax <value>		Sets maximum control value.
10	_pcs4 ctrlmax?		Returns current maximum control pressure.
11	_pcs4 ctrlmin <value>		Sets minimum control value.
12	_pcs4 ctrlmin?		Returns current minimum control pressure.
13	_pcs4 default		Sets default values into instrument.
14	_pcs4 err?		Returns the error number and description.
15	_pcs4 func ctrl <value> <unitno>		Instrument placed in control mode at <value> pressure in <unitno> units.
16	_pcs4 func F1		Toggles between absolute and gauge modes if an internal barometric sensor is installed.
17	_pcs4 func meas		Instrument placed in measure mode.
18	_pcs4 func stby <unitno>		Instrument placed in standby mode in <unitno> units.

Ref	Command	Data	Function / Response
19	_pcs4 func vent <unitno>		Instrument placed in vent mode in <unitno> units.
20	_pcs4 id?		Returns instrument ID.
21	_pcs4 opt?		Returns instrument options.
22	_pcs4 outform <digit>		Sets output format.
23	_pcs4 outform?		Returns the current output format.
24	_pcs4 rangemin?		Returns the minimum pressure of the active transducer.
25	_pcs4 span?		Returns the stored multiplication factor from the active transducer and turndown.
26	_pcs4 stabledelay <value>	1 to 255	Sets the number of consecutive readings that the pressure must remain within the stable window for a pressure stable indication.
27	_pcs4 stabledelay?		Returns the number of readings that must be within the stable window before a stable pressure is indicated.
28	_pcs4 stablewindow <value>		Sets the pressure window that is used to indicate pressure is stable.
29	_pcs4 stablewindow?		Returns the pressure tolerance allowed for a stable pressure indication as a % of span of the active transducer.
30	_pcs4 stat?		Returns mode and stable flag status "mode, stable CR LF".
31	_pcs4 unit <unitno>		Sets the instrument to specified engineering units.
32	_pcs4 unit?		Returns the current engineering units and type of transducer (A, G, D).
33	_pcs4 xducer?		Returns the number of the currently active transducer.
34	_pcs4 zero?		Returns the stored zero offset of the active transducer and turndown in the current pressure units.

7.6.2 PCS 200 Emulated Commands and Queries

Table 7.6.2 – PCS 200 Emulated Commands and Queries

Command	Data	Function / Response
CX		Control Pressure at last control point and units
C\$nnnnnnnX		Control Pressure at n in units \$
D#X		CAL POINT CONTROL MODE NOT SUPPORTED
EX		Clear Error/Clear Service Request
E?X		Return error code and clear error
F\$nnnnnnn1X		Re-initialize; \$,n ignored
F\$nnnnnnn2X		RETURN CAL DATA NOT SUPPORTED
F\$nnnnnnn3X		Return Unit ID string; \$,n ignored
F\$nnnnnnn5X		RETURN QPS TEMPERATURE NOT SUPPORTED
F\$nnnnnnn6X		RETURN NULL METER READING NOT SUPPORTED

Modular Precision Pressure Controller

CPC6000

Command	Data	Function / Response
F\$nnnnnnn7X		RETURN VACUUM GAUGE READING NOT SUPPORTED
F\$nnnnnnn8X		Return Clock Reading (Time); \$,n ignored
F\$nnnnnnn9X		Return Pressure Control Limits; \$,n ignored
MX		Measure Pressure in current pressure units
M\$X		Measure Pressure in units specified by \$
M\$nnnnnnnX		Measure Pressure in units specified by \$; n ignored
M\$nnnnnnnsX		Measure Pressure in units specified by \$; n,s ignored
Q#X		SEQ FUNCTIONS NOT SUPPORTED
RX		Not supported
R0X		Return to Standard Output Format
R1X		Re-initialize DO NOT USE - sets CPC6000 to command prompt.
R2X		RETURN CAL DATA NOT SUPPORTED
R3X		Return unit ID string
R5X		RETURN QPS TEMPERATURE NOT SUPPORTED
R6X		RETURN NULL METER READING NOT SUPPORTED
R7X		RETURN VACUUM GAUGE READING NOT SUPPORTED
R8X		Return Clock Reading (Time)
R9X		Return Pressure Control Limits (Min and Max)
SX		Standby Mode
S\$X		Standby Mode; \$ ignored
S\$nnnnnnnX		Standby Mode; \$,n ignored
S\$nnnnnnnsX		Standby Mode; \$,n,s ignored
U\$X		Change Units to units specified by \$
VX		Vent Mode in current units
V\$X		Vent Mode in units specified by \$
V\$nnnnnnnX		Vent Mode in units specified by \$; n ignored
V\$nnnnnnnsX		Vent Mode in units specified by \$; n,s ignored
ZX		Automatic re-zero

7.6.3 SCPI Emulation

7.6.3.1 SCPI Commands and Queries

Note:

Section 7.6.3.1 is for SCPI 7010. SCPI WIKA has the same commands, but uses bar units only!

STATus:

OPERation
:CONDition? Returns an integer value representing instrument status that can be decoded.
Bit 0: Zeroing active.
Bit 1: Control Setpoint has not been reached.
Bit 2: Reserved 0.
Bit 3: Reserved 0.
Bit 4: Measuring. The instrument is actively measuring.

MEASure

[:PRESSure] [z]? Returns the pressure from the active sensor, or active sensor if [z] is omitted.
:TEMPerature[z]? Returns the temperature in deg. C. from the specified sensor, or active sensor if [z] is omitted.
:RATE[z]? Returns the pressure rate from the specified sensor, or active sensor if [z] is omitted.
:BAROmetric? Returns the barometric pressure, if a barometer sensor is installed.

CALibration

:MODE? Returns 1 if the sensor has been calibrated or 0 if not.
:DATE? Returns the stored calibration date.
:DATE <i,i,i> Sets the calibration date (YYYY,MM,DD).
:ZERO? Returns current zero point correction.
:ZERO <n> Sets the zero so the currently measured pressure matches the commanded value. Limited to +/-5% FS.
ZERO:RUN Vents the instrument and sets zero so the currently measured pressure = 0.

SENSE

[:PRESSure] [z] Selects the sensor to read or modify or active sensor if [z] is omitted.
:NAME? Returns the sensor and which turndown is active
:MODE? Returns pressure type "ABSOLUTE" or "GAUGE"
:MODE ABS/GAUGE Sets the pressure type to absolute or gauge.
:ABS? Returns native sensor type "1" for absolute, "0" for gauge.
:RESolution? Returns the FS-related relative resolution of the sensor.
:RANGE
[:UPPer]? Returns the maximum range of the primary sensor.
[:LOWer]? Returns the minimum range of the primary sensor.
:Unit
[:NAME]? Returns a string representing the native units of the sensor.
:VALue? Returns the conversion factor of the native units of the sensor.
:REFerence
[:HEIGHT] <n> Sets the head height correction [mm].

:MODE? Returns head correction mode - "OFF", "GAS", LIQUIT".
 :MODE OFF/GAS/LIQUIT Sets the head correction mode.
 :MEDIUM <n> Sets the density of the medium.

SYSTEM

:CHANnel A/B Sets the active channel of the instrument.
 :CHANnel? Returns the active channel of the instrument.
 :DATE <i,i,i> Sets the system date (YY,MM,DD).
 :TIME <i,i,i> Sets the system time (hh,mm,ss).
 :ERRor[:NEXT]? Return: error#, "description".
 :KLOCK ON/OFF/1/0 Lock or unlock keyboard.
 :PRESet Load known values.
 :SAVe Saves settings to non-volatile memory.
 :VERSion? Return of the SCPI-standard.

TEST

:ELECTronic? Returns electronics status.
 :RELAy<n>? Returns whether relay 1 to 3 is closed or not.
 :RELAy<n> ON/OFF Turns relay 1 to 3 on or off.

UNIT

:NAME<n>? Returns the name of the unit with index n.
 :FACTOR<n>? Returns the conversion factor of the unit with index n.
 :PRESsure <n> Changes the current units, where <n> is the index of the units you wish to switch to. Here is a list of the indexes:

<u>index</u>	<u>unit</u>
0	bar
1	mbar
2	pascal
3	PSI
4	ATM
5	kg/cm2
6	PSF
7	kPa
8	cmH2O
9	inH2O
10	inH2O
11	ftH2O
12	uHg
13	mmHg
14	cmHg
15	inHg
16	inHg
17	
18	User
19	User
20	User

OUTPut

:STATe ON/OFF/1/0 Turns control mode on or off.
 :STATe? Returns control mode "0" for off, "1" for on.

:MODE MEASure/CONTRol/VENT Sets the operation mode.
 :MODE? Returns current operation mode MEASURE”, CONTROL”or “VENT”.
 :STABLE? Returns 1 if in control mode and stable.
 :AUTOvent ON/OFF/1/0 Sets autovent function on or off (automatically vent when controlling at zero).
 :AUTOvent? Returns status of Autovent function.

[SOURCE]

:PRESsure
 [:LEVel]
 [:IMMediate]
 [:AMPLitude] <n> Sets the control pressure.
 [:AMPLitude]? Returns current control pressure value.
 :SLEW <n> Sets the slew rate in %FS/s.
 :SLEW? Returns the current slew value in %FS/s.
 :TOLerance <n> Sets the tolerance for stable indication in %FS.
 :TOLerance? Returns the tolerance for stable indication in %FS.

CALCulate

:LIMit
 :LOWer <n> Sets minimum control limit.
 :LOWer? Returns minimum control limit.
 :UPPer <n> Sets maximum control limit.
 :UPPer? Returns maximum control limit.

7.6.3.2 SCPI Commands Output Formats

1. <sp>pressure value<cr><lf>
2. <sp>pressure, units number, mode<cr><lf>
3. <sp>pressure, pressure rate<cr><lf>
4. <sp>pressure, minimum peak, maximum peak<cr><lf>
5. <sp>pressure, active sensor (P or S) active turndown (1-4)<cr><lf>
6. <sp>pressure, control point, “stable” or “slewing”<cr><lf>
7. <sp>pressure, “no barometer” or baro reading<cr><lf>

7.6.3.3 SCPI Commands Error Messages and Error Codes

A recognized command is displayed at the device in the headline with “Remote...”. In case of error “Remote error...” is displayed. A maximum of 100 errors are stored and can be retrieved successfully.

Table 7.6.3.3 - SCPI Commands Error Messages and Error Codes

Code	Error String Returned
0	No error
-101	Undefined character
-102	Syntax error
-103	Undefined separator
-104	Parameter data type error
-109	Parameter missing

Code	Error String Returned
-110	Undefined header
-113	Undefined command
-114	Parameter out of range
-313	Calibration data not found
-315	Configuration data not found
-350	Errorqueue overflow
-410	Query interrupted
600	Default configuration not found
601	Calibration mode active! Deactivate before setting C0..C3
602	Sensor not available
701	DCS instance not available
702	Create DCS instance failed
703	DCS still active
704	Command currently not allowed

7.6.4 DPI 510 Emulation

The CPC6000 will accept and respond to Druck Model DPI 510 remote commands over a GPIB as listed below. These commands can be sent individually, or ganged together. Delimiters (separators) between commands are not required.

7.6.4.1 DPI 510 Supported Commands and Queries

Table 7.6.4.1 - DPI 510 Supported Commands and Queries

case '#':		
	usage "#L{nn}"	Simulate GPIB listener at address nn over serial port. Does not support multidrop.
	usage "#T{nn}"	Simulate GPIB talker at address ad over serial port. Does not support multidrop.
case '@':		/*Error Status (on/off)*/
	usage "@0"	sets error checking off
	usage "@1"	sets error checking on
case 'C':		/*Control_Mode / Measure_Mode*/
	usage "C0"	go to measure mode
	usage "C1"	go to control mode
	usage "C2"	go to standby mode
case 'D':		/*Display_Mode*/
	usage "D0"	returns active reading in any mode
	usage "D1"	returns setpoint only if in control mode, otherwise it returns 0.000
case 'E':		/*Clear_Error_Mode*/

	usage "E"	The PCS 400 will accept all types of termination; CR/LF/EOI. It will also accept the strings E0, E1 and E2, but will not respond to these.
	Note: Send "E?" to clear an error from the buffer (this is an added function, not part of the Druck command set).	
case 'F':		/*Function*/
	usage "F00"	does not apply to PCS 400
	usage "F01"	puts instrument into vent mode when C0 or controller is off
	usage "F02"	does not apply to PCS 400
	usage "F03"	does not apply to PCS 400
case 'I':		/*IO Service Request*/
	usage "I0"	dummy function accepts the string and returns what was entered
	usage "I1"	dummy function accepts the string and returns what was entered
	usage "I2"	dummy function accepts the string and returns what was entered
	usage "I3"	dummy function accepts the string and returns what was entered
	usage "I4"	dummy function accepts the string and returns what was entered
	usage "I5"	dummy function accepts the string and returns what was entered
	usage "I6"	dummy function accepts the string and returns what was entered
case 'J':		/*Rate_Mode*/
	usage "J0"	sets the rate mode to variable rate mode
	usage "J1"	sets the rate mode to variable rate mode
	usage "J2"	sets the rate mode to regular control mode (default) MAX
	Note: All of the notation formats have a leading space!	
case 'N':		/*Notation_Mode*/
	usage "N0"	output format default responds with pressure/remote/range/scale/display/error
	usage "N1"	output format responds with pressure or setpoint depending on the display mode setting
	usage "N2"	output format responds with range/scale/display/control mode/IO/function/error
	usage "N3"	output format returns 0 for not stable or 1 for stable
	usage "N4"	output format returns error/error(on/off)/rate/variable rate/units
	N0	if display is set to 1 the pressure reading is the setpoint reading example 200.00REMR1S3D1@01 if display is set to 0 the pressure reading is the pressure reading example 199.98REMR1S3D0@01
	N1	if display is set to 1 the pressure reading is the setpoint reading example 200.00 if display is set to 0 the pressure reading is the pressure reading example 199.98
	N2	example R1S3D1C0I0F00@01
	N3	example 1

	N4	@01@1J0V+00009U BAR
case 'P':		/*Pressure_Setpoint_Mode*/
	usage "PXXXX. XXXX"	X = sets the pressure setpoint (ex. P13.5)
case 'R':		/*Range(xducer)*/
	usage "R0"	no range
	usage "R1"	range 1 if available (main range)
	usage "R2"	range 2 if available (secondary range)
case 'S':		/*Scale*/
	usage "S1"	sets the scale with one unit selection
	usage "S2"	sets another scale with another unit selection
	usage "S3"	sets the global scale enables all units to be selected
case 'U':		/*Units*/
	usage "UX"	X = the unit number (ex. U16 = psi)
case 'V':		/*Variable_Rate_Mode*/
	usage "VXXXXX"	X = the desired control rate setting (ex. V1)
case 'W':		/*Wait_Value_Mode*/
	usage "WXXX"	X = the desired stable delay setting in seconds (ex. W005 = 5 sec)

7.6.4.2 DPI 510 Unsupported Commands and Queries

Table 7.6.4.2 - DPI 510 Unsupported Commands and Queries

usage "A"	does nothing
usage "E "	does nothing
usage "O"	Zeroing, software will accept the command but does not affect the zero status of the instrument
usage "R0"	setting remote to local
usage "R1"	setting to remote
usage "I0"	does nothing
usage "I1"	does nothing
usage "I2"	does nothing
usage "I3"	does nothing
usage "I4"	does nothing
usage "I5"	does nothing
usage "I6"	does nothing
UNITNO 7	(kg/m2) does nothing

UNITNO 10	(mHg) does nothing
UNITNO 17	(lb/ft2) does nothing
UNITNO 21	(Special) does nothing

7.6.4.3 DPI 510 Measurement Units

The Measurement units below use conversion factors as listed in this manual's Appendix:

Table 7.6.4.3 - DPI 510 Measurement units

Druck Unitno	Units	Comments
1	Pa	
2	kPa	
3	mPa	
4	mbar	
5	bar	
6	kg/cm2	
7	kg/m2	not supported
8	mmHg	
9	cmHg	
10	mHg	not supported
11	mmH2O	
12	cmH2O	
13	mH2O 20c	
14	torr	
15	Atm	
16	psi	
17	1b/ft2	not supported
18	inHg	
19	"H2O 04c	
20	'H2O 04c	
21	Special	not supported
22	"H2O 20c	
23	'H2O 20c	

NOTES

8. Options

This section lists options available for the CPC6000. Users might consider letting the factory install a special feature not listed here. Mensor welcomes the opportunity to quote on such requests. The cost of adding an enhancement frequently will amortize itself in a very short time because of improved process efficiency.

8.1 Transport Case (PN 0017211001)

A wheeled transport case is available suitable for moving the CPC6000 between sites, or as an air-freight (or other) shipping container. The case is constructed of a high impact plastic with a black exterior. It includes a piano hinge, an anodized interlocking tongue and groove opening, various nickel-chrome and stainless steel fixtures, a metal with rubber guard satchel style handle and a retractable pull-out handle. The interior is filled with high density polyurethane foam with a die-cut cavity to cradle the instrument with fitting adapters in place, and an additional cavity to store related accessories. Rugged and weather resistant, the case makes an attractive, practical shipping and moving container. The case weighs approximately 24 pounds (10.89 kg) unloaded. Nominal dimensions are 25 inches by 20.3 inches by 12.8 inches (63.50 cm x 51.56 cm x 32.51).



Figure 8.1 - Transport Case

8.2 Rack Mount Kit

A rack mount kit allows the customer to install a CPC6000 into a standard 19" instrument rack. It includes pre-installed brackets on the sides of the instrument as well as spacer panels and hardware to rack mount the CPC6000.

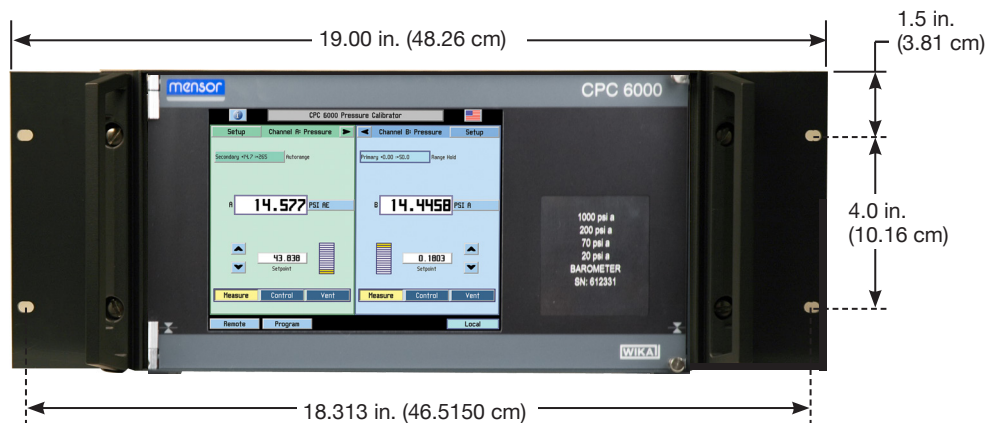

Figure 8.2 - Rack Mount Kit

8.3 Calibration Sled Kit

The calibration sled allows customers to calibrate transducers outside the CPC6000. This allows the customer to continue using the other ranges inside the CPC6000, while calibrating one of the transducers in order to reduce down-time. The calibration sled kit includes the serial interface software, the calibration sled, a serial cable to connect the sled to the host computer, and a power supply (not pictured) for the calibration sled (see Figure 8.3).



Figure 8.3 - Calibration Sled Kit

8.4 Additional Transducers

A secondary transducer of any standard range, with up to two turndown ranges, can be purchased as an option. In all other regards, the add-on transducer will meet all of the specifications and operating parameters outlined throughout this manual.



Each control channel has pressure control limits. Typically, the pump regulator modules have a maximum limit of 15 psig and the solenoid valve regulator modules have limits of 50-150 or 1500 psig. If a sensor is placed into a control channel where the sensor has a higher upper pressure range than the control module, the maximum control limit will be limited to the maximum range of the control module.

While any sensor will function in any control channel, the results may not always be optimum. For example, if a 1 psi sensor is placed in a control module that has a 1500 psi upper limit, the controlled pressure stability may not be acceptable. Or if a 1500 psi module is placed in a control module that has a 30 psi upper limit, it will control very well, but be limited in resolution.

8.4.1 Secondary Transducer Installation

If the add-on transducer is of a higher full scale range than the existing primary transducer, then this newer transducer becomes the Primary, and the existing transducer must be moved to the Secondary Transducer berth. For complete installation instructions see the text under “Transducer Replacement” in [Section 9](#), Maintenance.

8.5 Barometric Reference Transducer

The removable/interchangeable Barometric Reference Transducer is a very stable, absolute pressure device used to accurately measure local atmospheric pressure, and is used to emulate gauge pressure when the native transducers are absolute and absolute when the native sensors are gauge.

Both channels can use the single barometer to read and for use in emulation.

8.5.1 Gauge Pressure Emulation Key

On absolute units set the CPC6000 for gauge pressure measurement and control by touching [Pressure Units] which will display the Units pop-up window shown in Figure 6.3.6. In the upper right corner of this window is an [Absolute/Gauge] toggle key. Press [Absolute] to change to [Gauge], then press [OK]. The operation screen now shows Units [GE] in place of Units [A]. The “GE” indicates that the measurement and control values are in Gauge Emulation pressure units.

In the Gauge Emulation mode the atmospheric pressure reading from the barometric reference transducer is subtracted from the absolute pressure reading of the active channel to emulate a gauge pressure.

The barometric reference sensor has six significant digits. If a very low pressure gauge sensor is active and is used in absolute emulation, the combined output may appear quite noisy because of the resolution of the barometric reference.

Emulation mode uncertainty is the combined uncertainty of the barometric reference transducer and the active transducer.

8.5.2 Absolute Pressure Emulation Key

On gauge units set the CPC6000 for absolute pressure measurement and control by touching [Pressure Unit] which will display the Units pop-up window. In the upper right corner of this window is an [Absolute/gauge] toggle key. Press [Gauge] to change to [Absolute], then press [OK]. The operation screen now shows Units [AE] in place of Units [G]. The “AE” indicates that the measurement and control values are in absolute emulation pressure units.

In Absolute Emulation mode the atmospheric pressure reading from the Barometric Reference Transducer is added to the gauge pressure reading of the active channel to emulate absolute pressure.

8.5.3 Calibration

The Barometric Reference Transducer can be calibrated in exactly the same manner as the other installed sensors as described in [Section 10](#), Calibration.

8.5.4 Specifications

Accuracy: 0.01% of reading. Uncertainties include all pressure effects, temperature effects over the calibrated range and calibration stability for 365 days after re-zeroing.

Pressure Range: Calibrated from 8 to 17 psia.

Resolution: 4 to 6 digits.

8.6 Virtual Delta Channel

8.6.1 Delta Functions

Two virtual delta functions are available: A-B and B-A. The delta functions are strictly a mathematical difference between the two physical channel readings. There is no pressure connection between the channels.

8.6.2 Screen Source

The CPC6000 has two frames in which channel information can be displayed. The frame channel source can be programmed to A(left) B(right) or A(left) Delta(right) or Delta(left) B(right). Either frame can be minimized as before.

8.6.3 Configure Button

In order to allow the delta function and frame channel source to be changed, a new button was added to the lower toolbar. This button is labeled 'Configure' and only appears when the Delta function is enabled. Pressing this button brings up a window with radio buttons to select the desired configuration as shown in Figure 8.6.3.

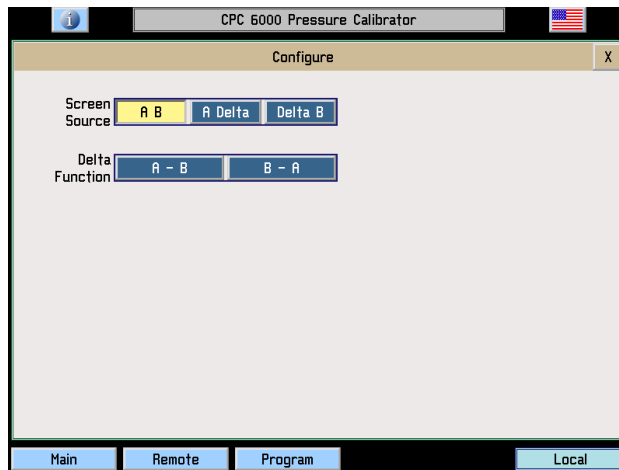

Figure 8.6.3 - Configure Button Display Screen

8.6.4 Slave Channel Display

Since the range information is not applicable to the delta channel, the slave channel (the physical one not displayed) reading is displayed where the range droplist appears in the normal screen.

8.6.5 Screen Source A B

Channels are completely independent. Operates just like a standard CPC6000.

8.6.6 Screen Source A Delta

A is displayed on the left and is the leading channel. Delta is displayed on the right and is either A-B or B-A as selected. Channel B's reading is displayed where the range information normally appears on the Delta channel. Channel B is the slave channel. Whenever the A channel is changed, the B channel setpoint is changed to maintain the differential setpoint displayed on the Delta channel. Whenever the Delta channel setpoint is changed, the B setpoint is changed as well.

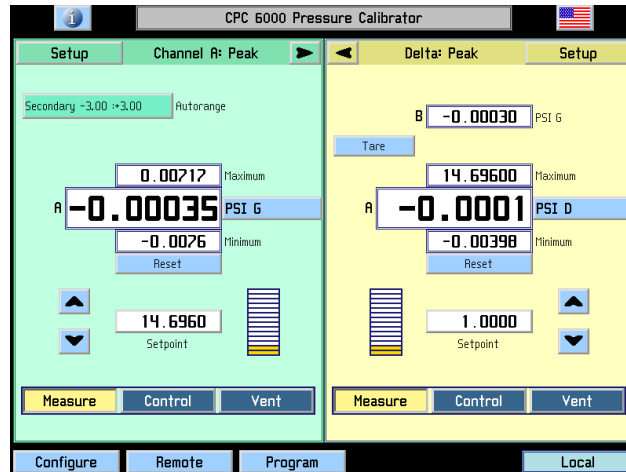

Figure 8.6.6 - Screen Source A Delta

8.6.7 Screen Source Delta B

Delta is displayed on the left and is either A-B or B-A as selected. B is displayed on the right and is the leading channel. Channel A's reading is displayed where the range information normally appears on the Delta channel. Channel A is the slave channel. Whenever the B channel is changed, the A channel setpoint is changed to maintain the differential setpoint displayed on the Delta channel. Whenever the Delta channel setpoint is changed, the A setpoint is changed as well. Tare, when activated, zeros the delta channel. When Tare is deactivated it reverts back to the previously set A-B or B-A calculation.

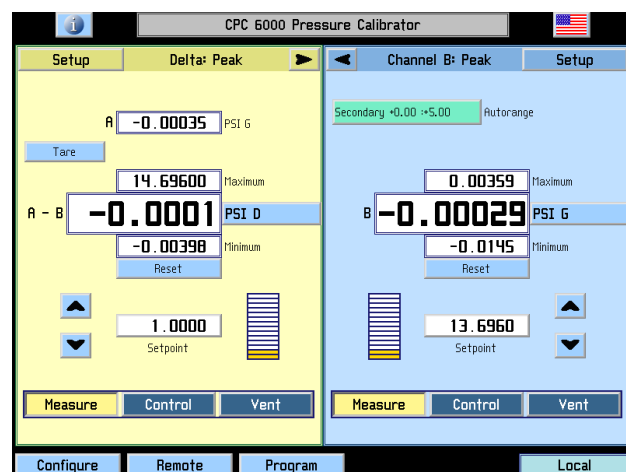

Figure 8.6.7 - Screen Source Delta B

8.6.8 Delta Control Limits

The default control limits for the Delta channel are the maximum limits possible. Certain combinations of setpoints will generate an illegal setpoint on the slave channel. Note that whether or not the setpoint is illegal is dependent on the measured reading of the leading channel. In order to prevent the CPC6000 from rejecting control points that may become legal in the future, all possible setpoints are allowed unless restricted by setting the control limits to other values.

8.6.9 Delta Units Type

The delta units type is Differential and a D appears after the units label. Emulation is not available on the delta channel. If channel A and B are not set to the same pressure type, the delta reading may be ambiguous.

8.6.10 Setup Screens

The delta channel does not have the following setup buttons: STATUS, CAL, TEST, CONTROL CAL, control parameters except limits and stable. To change parameters on the slave channel, you must select the A,B (normal) screen source.

8.6.11 New Commands

Table 8.6.11- New Commands

Command	Data	Function/Response
CHAN D	None	Sets the active channel to the Differential channel.
*DELTAFUNC A-B	None	Sets the delta to be the result of the channel A reading – channel B reading.
*DELTAFUNC B-A	None	Sets the delta to be the result of the channel B reading – channel A reading.
*DELTAFUNC?	<sp>{A-B or B-A} <cr><lf>	Returns delta function as one of the above options.
SCREENSRC A,B	None	Sets the CPC6000 to normal operation screen displaying A and B channels.
SCREENSRC A,Delta	None	Sets the CPC6000 to display A channel as normal, and Delta channel replaces the B channel location. In this mode the “A” channel is considered the leading channel.
SCREENSRC Delta,B	None	Sets the CPC6000 to display B channel as normal, and Delta channel replaces the A channel location. In this mode the “B” channel is considered the leading channel.
SCREENSRC?	<sp>{A,B or A,Delta or Delta,B}<cr><lf>	Returns screen source as one of the above options.
TARE	on/off	Sets the tare function to on or off, Delta channel only.
TARE?	On/Off<cr><lf>	Returns whether the tare function is on or off.

**NOTE: Chan D must be the active channel.*

8.7 Dual Solenoid Single Output

This option adds two external solenoids that will isolate the “A” channel output from the “B” channel output and allow the customer to have only one output connection. Channel A and B are mutually exclusive channels, so when either channel is switched out of STANDBY, the other channel will be VENTed, then switched to STANDBY mode. There is a delay involved when switching channels, so programmers will have to be aware of this.

The software controls the activation of the external solenoids based on the mode of each channel.



Caution

CAUTION: The solenoid when energized will get “HOT”.

Below is a rear view illustrating the plumbing:



Figure 8.7 - Rear view illustration of plumbing for the Dual Solenoid Single Output Option

NOTES

9. Maintenance

The CPC6000 was designed for maintenance-free operation. User maintenance is not recommended. A list of accessories is listed in Table 9.4. If you have questions not covered by this manual, call 1.800.984.4200 (USA only), or 1.512.396.4200 for assistance, or send an e-mail to tech.support@mentor.com.

9.1 Beyond the Warranty

Take advantage of Mensor's expert product care. Mensor, LP provides complete maintenance and calibration services, available for a nominal fee. Our service staff is knowledgeable in the innermost details of all of our instruments. We maintain units that are in operation in many different industries and in a variety of applications, and by users with a wide range of requirements. Many of these instruments have been in service for over twenty years, and continue to produce excellent results.

Returning your instrument to Mensor for service benefits you in several ways:

1. Our extensive knowledge of the instrument assures you that it will receive expert care.
2. In many cases we can economically upgrade an older instrument to the latest improvements.
3. Servicing our own instruments which are used in "real world" applications keeps us informed as to the most frequent services required. We use this knowledge in our continuing effort to design better and more robust instruments.

9.2 Troubleshooting the Pneumatic System of the CPC6000



Caution

PROCEED WITH CAUTION! The following test feature is a powerful troubleshooting tool, but it incurs a dangerous potential for misdirecting high pressures. Study the pneumatic schematics (Figures 9.2.1C and 9.2.2B) to understand the possible consequences of various pressure routings.

9.2.1 Pump Regulator

The CPC6000 has two Controller test screens; one is for the Pump Regulator (see Figure 9.2.1A) and the other is for the Solenoid Valve Regulator (see Figure 9.2.2A).

To get to the test screen press [Setup], [Controller], and [Test]. The pump regulator test screen allows control of the solenoid valves directly by the operator. Pressing the key labeled [Closed] or [Open] will toggle the associated solenoid between the open and closed states. As each key is pressed the key will change text and color, and the target solenoid will make an audible “click”. If a key changes color without the accompanying click it is an indication of a defective solenoid or a bad connection. Pressing the [+] or [-] key will actuate the pump and increase or decrease the system pressure respectively. The [speed] key allows adjustment of the relative rate at which the pump operates to increase or decrease pressure. The [%] key allows an adjustment of the duty cycle of the supply and exhaust valves. The Primary and Secondary labels show the pressure sensed at the respective transducers. The Rate [psi/sec.] label indicated the rate of change of the system pressure. See Figure 9.2.1B for the pump regulator pneumatic module. See Figure 9.2.1C for the pneumatic schematic for the pump regulator.

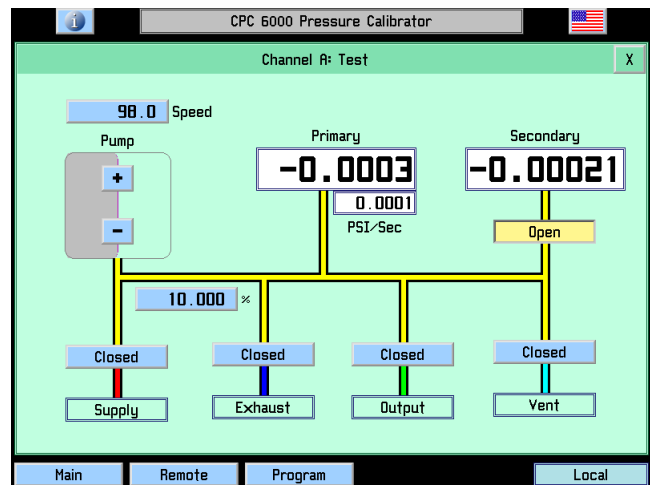
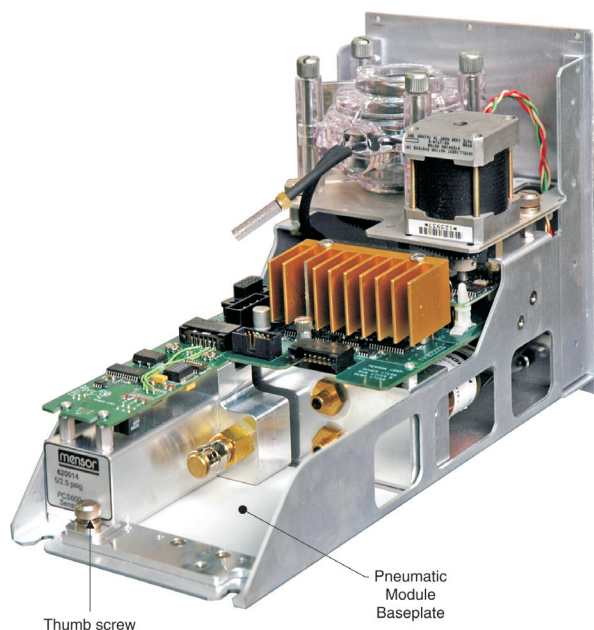

Figure 9.2.1A - Test Screen, Pump Regulator



Caution

System pressure should not be driven above the range of the primary transducer.

The valve isolating the secondary transducer should be closed before the system pressure is driven above the range of the secondary transducer.

Figure 9.2.1B - Pneumatic Module, Pump Regulator

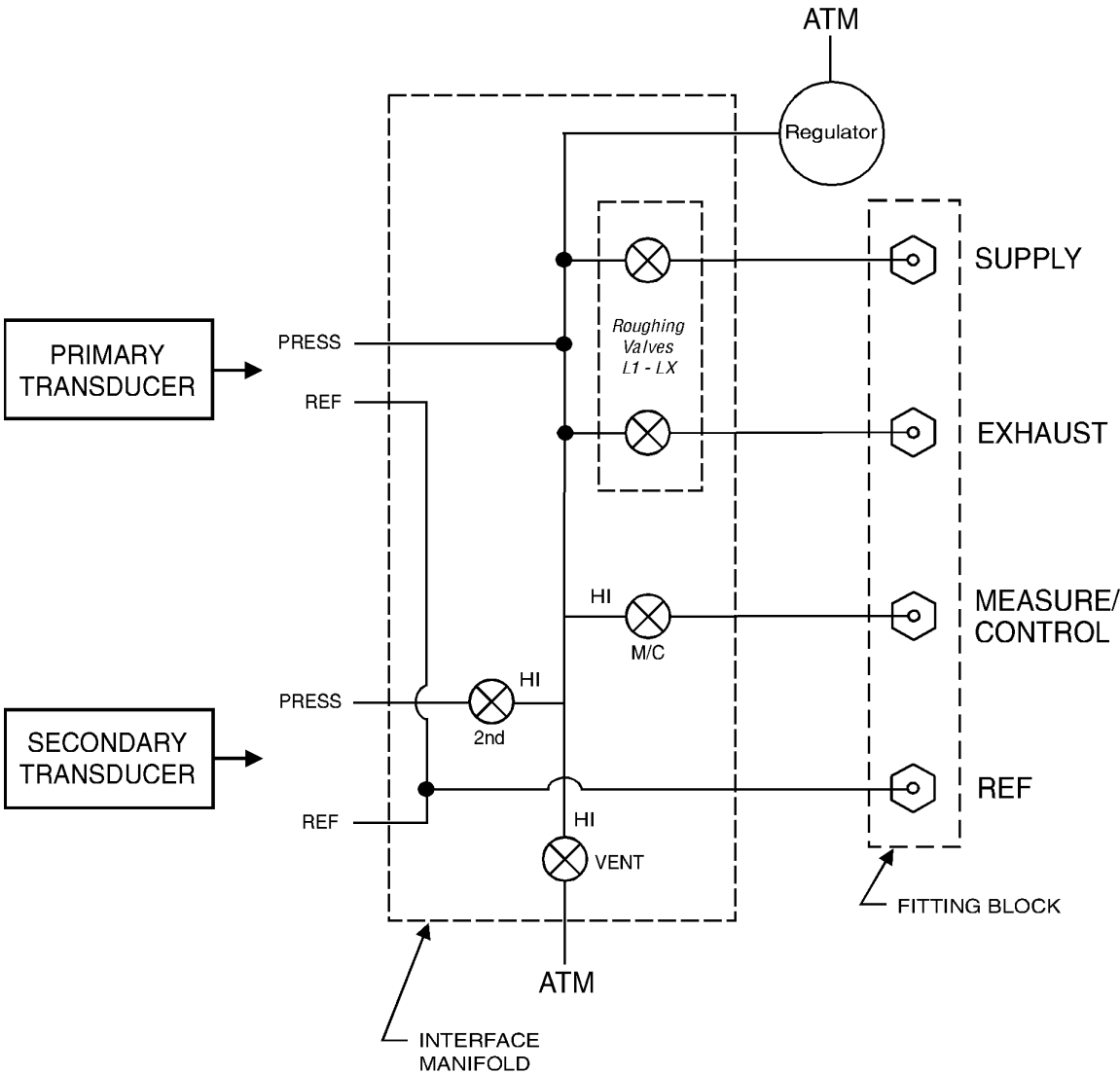

Figure 9.2.1C - Pneumatic Schematic, Pump Regulator

9.2.2 Solenoid Valve Regulator

The Solenoid Valve Regulator test screen (figure 9.2.2A) allows control of the solenoid valves directly by the operator. Pressing [Closed] or [Open] key will toggle the associated solenoid between the open and closed states. As each key is pressed the key will change text and color, and the target solenoid will make an audible “click”. If a key changes color without the accompanying click it is an indication of a defective solenoid or a bad connection. The [+], [++], and [+++] represent the fine, medium and course regulator supply valves respectively. The [-], [--], [---] keys represent the fine, medium and course regulator exhaust valves respectively. Applying a continuous touch to any of these keys will open the respective regulator valve and increase or decrease the system pressure. The [%] key (top left) allows a collective adjustment of the duty cycle of the regulator valves to adjust the flow rate through the regulator. The Primary and Secondary labels show the pressure sensed at the respective transducers. The Rate [psi/sec.] label indicated the rate of change of the system pressure. See Figure 9.2.2B for the pneumatic schematic for the solenoid valve regulator.

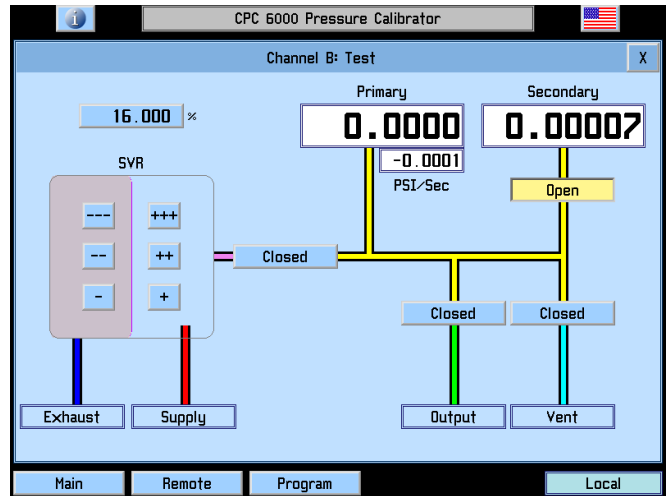

Figure 9.2.2A - Test Screen, Solenoid Valve Regulator



Caution

System pressure should not be driven above the range of the primary transducer.
The valve isolating the secondary transducer should be closed before the system pressure is driven above the range of the secondary transducer.

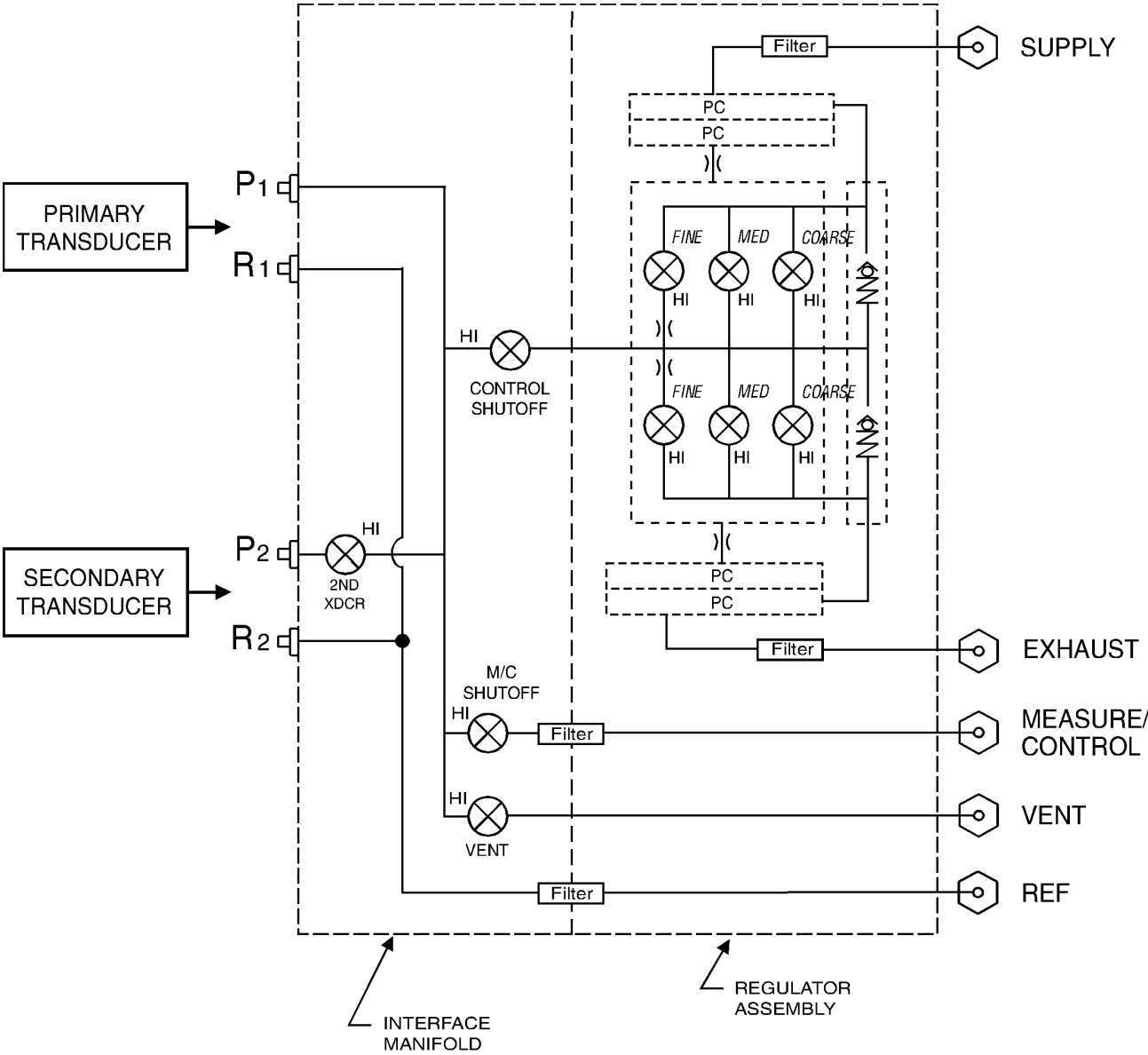

Figure 9.2.2B - Pneumatic Schematic, Solenoid Valve Regulator

9.2.2.1 Tuning a Solenoid Valve Regulator Module

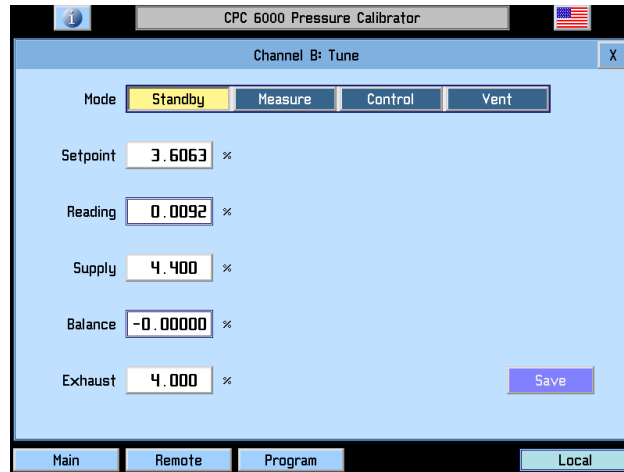

Figure 9.2.2.1 - Tune Screen, Solenoid Valve Regulator

9.2.2.1.1 Modes

[Standby]: Seals all outside connections.

[Measure]: Isolates the active sensor and measure/control port.

[Control]: Controls to displayed setpoint in % F.S.

[Vent]: Opens manifold to atmosphere.

Setpoint = Desired pressure in % F.S.

Reading = Measured pressure in % F.S.

Supply = Supply fine bleed valve.

Balance = Balance between supply and exhaust fine valves.

Exhaust = Exhaust fine bleed valve.

[SAVE]: Saves the supply and exhaust fine bleed valves to the regulator.

Typical supply and exhaust values will be 3.00 to 6.00.

9.2.2.1.2 Tuning Procedure

1. Plug Measure/Control port.
2. Connect supply pressure equal to 110% of the maximum range for that channel and a vacuum pump if necessary.
3. Press [Setup] [Controller] [Tune] on the channel you wish to tune.
4. Press the box to the right of the Setpoint and enter 50.00 and [OK].
5. Push the [Control] button and watch the value in the box to the right of Reading climb towards the setpoint.
6. If the Reading stays below the Setpoint increase the Supply value by .1 until the setpoint is reached.
7. Again press the box to the right of Setpoint and enter 25.00 and [OK].
8. If the Reading stays above the Setpoint increase the Exhaust value by .1 until the setpoint is reached.
9. Return again to the Setpoint of 50 by repeating step 4.
10. Evaluate the way the reading reacts when approaching the setpoint and repeat steps 6 and 8 until the desired result is reached.
11. When you are satisfied with the performance of the regulator, press the [Save] button to store the changes you have made to the regulator. These values are stored in nonvolatile memory on the regulator and they will be saved through power cycles.

9.3 Replacing Modules



CAUTION: ESD PROTECTION REQUIRED. The proper use of grounded work surfaces and personal wrist straps are required when coming into contact with exposed circuits (printed circuit boards) to prevent static discharge damage to sensitive electronic components.

Always store loose transducers and PC boards in static protective bags or containers.

9.3.1 Transducer Removal

1. **VENT THE SYSTEM!** Then turn off the power.
2. Loosen the two captive screws on the front panel (Figure 3.3), and swing the panel open.
3. Unscrew the thumb screw holding in the transducer (Figures 9.2.1B and 9.3.1).
4. Apply a light inward pressure against the bottom of the transducer case, just below the range label, while tilting the case upward to clear the clamp plate and screw head.
5. Pull the transducer module outward, through the front opening.



Caution

CAUTION: There must be a transducer installed in the “Primary Transducer” berth for the system to function properly. If the system is operated with the primary berth empty the results will be unpredictable.

Removing a transducer disengages the electrical and pneumatic connections and seals off the pressure on the pneumatic module. This permits the CPC6000 to be turned on with the supply pressure connected even with no transducers installed.



Notice

Each control channel has pressure control limits. Typically, the pump regulator modules have a maximum limit of 15 psig and the solenoid valve regulator modules have limits of 50-150 or 1500 psig. If a sensor is placed into a control channel where the sensor has a higher upper pressure range than the control module, the maximum control limit will be limited to the maximum range of the control module.

While any sensor will function in any control channel, the results may not always be optimum. For example if a 1 psi sensor is placed in a control module that has a 1500 psi upper limit, the control stability may not be acceptable. Or if a 1500 psi module is placed in a control module that has a 30 psi upper limit, it will control very well, but be limited in resolution.



Caution

CAUTION: When transducers are replaced and the unit is rebooted, the default parameters will be loaded. If you are using custom settings they must be reloaded after transducer installation.



Caution

CAUTION: Do not install a high pressure transducer into a low pressure CPC6000. It is acceptable to install a low pressure transducer in a high pressure instrument, but control stability will be degraded.



Caution

CAUTION: Do not mix gauge and absolute pressure sensors on one control channel!



Figure 9.3.1 - Pneumatic Module, Solenoid Valve Regulator

9.3.2 Transducer Installation

To replace a transducer first make sure that it is going into the proper transducer berth in the pneumatic module. Each berth is clearly marked on the pneumatic module baseplate (see Figure 3.6). The “PRIMARY TRANSDUCER” must be the transducer with the highest pressure range.

To install a transducer with the front panel already open:

1. Rest the transducer on the baseplate and the retention bar. The transducer will be tilted down slightly.
2. Slide the transducer inward until resistance is felt. Then apply enough pressure against the transducer for it to clear the clamp so that it clears the retention bar and is fully seated and level on the baseplate.
3. Tighten the thumb screw to secure the transducer.
4. Swing the front panel closed and secure it by tightening the two captive screws.

9.3.3 Pneumatic Module Removal

1. **VENT THE SYSTEM!** Then turn off the power.
2. Remove top cover.
3. Remove all external pressure connections.
4. Remove the 6 slotted 2.5mm screws that fasten the pneumatic module rear panel to the chassis.
5. Inside the pneumatic module disconnect one 9-pin D-sub connector at the regulator, and the two connectors on the power cable.
6. Slide the pneumatic module out through the rear and clear of the chassis.



Notice

Pneumatic modules have EMI containment strips that may necessitate some force to remove modules.

9.3.4 Pneumatic Module Installation

To install or replace the pneumatic module, simply reverse the steps taken for its removal.

9.4 Accessories

Only accessories which meet the manufacturers specifications shall be used.

Table 9.4 – Accessories

Part Description	Part Number
Operation Manual	0017222001
Fuses	4100111150
Power Cord	4000400002
Fitting Adapter – 7/16-20 to 1/8 FNPT	0018203001
Fitting Adapter – 7/16-20 to 1/4 FNPT	0012688001
Pressure Transducer – Primary or Secondary (Calibrated)	0017218XXX Consult Mensor for specific ranges
Calibration Sled Kit	0017657001

9.5 Chassis Interior

Electrical Module

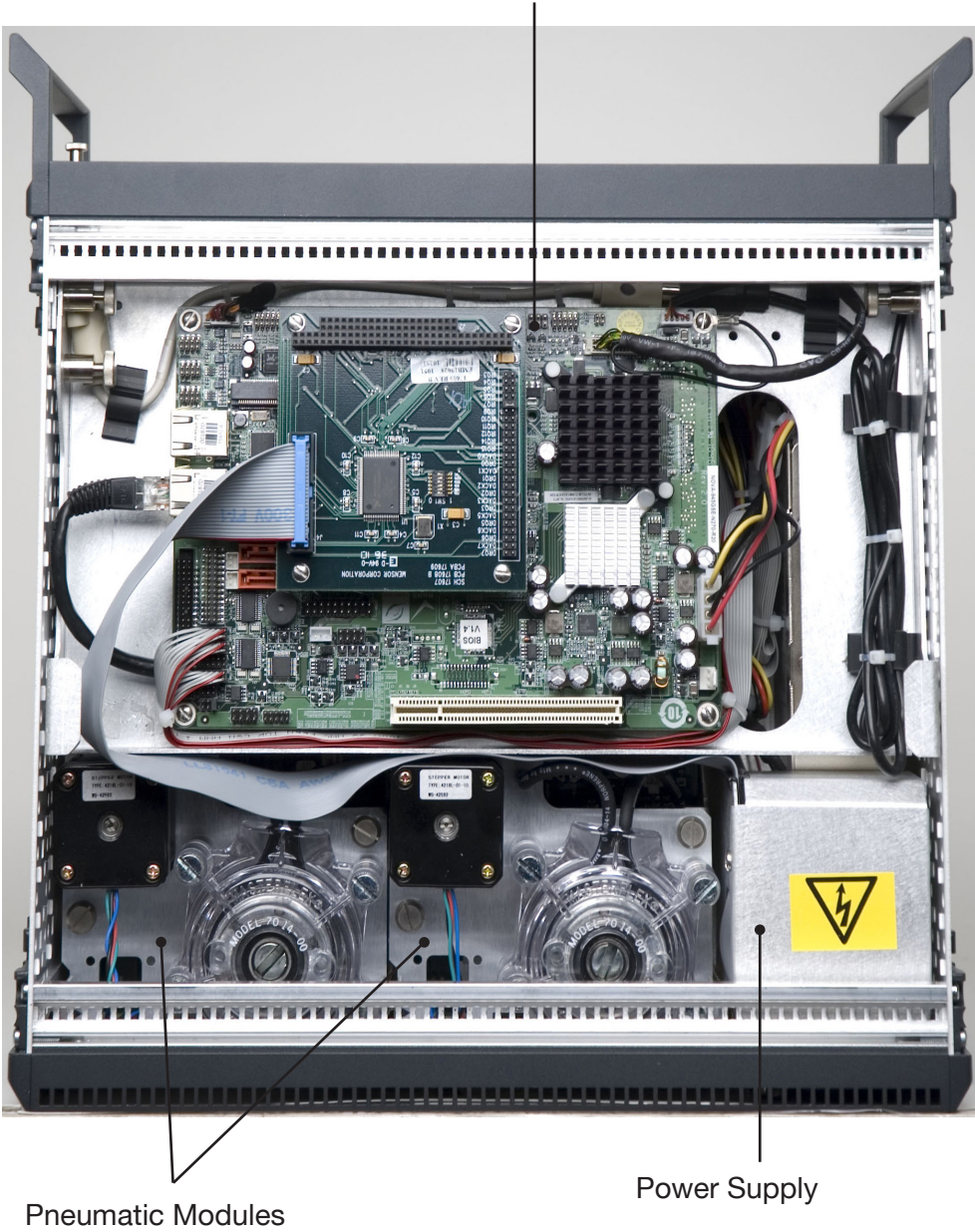

Figure 9.5A - Chassis Interior, Top View

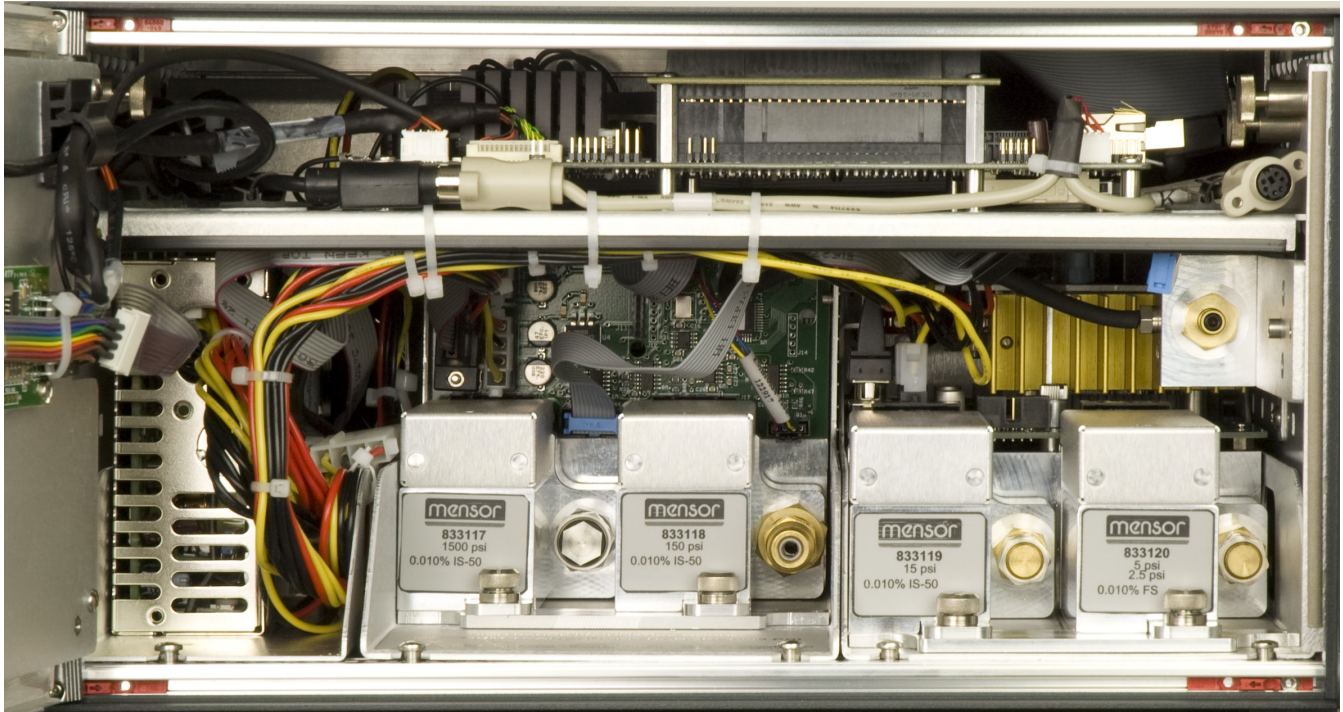

Figure 9.5B - Chassis Interior, Front View

10. Calibration

10.1 General

The CPC6000 automatically adjusts the pressure reading for the effects of temperature and non-linearity within the calibrated temperature range of 15-45°C. The process is referred to as dynamic compensation because each reading is so adjusted before it is output to the display or to a communication bus. Thus, a calibrated CPC6000 operated within its temperature band, and with proper zero and span adjustments, will provide accurate pressure measurements.

The transducer should have the span verified periodically to insure its stability. Initially, the recommended period between calibrations is as specified. This period may be extended as confidence is gained in the span stability.

10.2 Environment

For maximum accuracy, allow the CPC6000 to warm up for a minimum of 15 minutes in an ambient temperature within the compensated range prior to commencing a calibration. In addition the instrument should be at rest on a stable platform that is free of excessive vibration and shock.

10.3 Pressure Standards

Mensor recommends the use of appropriately accurate primary pressure standards when calibrating this instrument. Such standards should be sufficient so that when the techniques of the ISO Guide to the Expression of Uncertainty in Measurement (GUM) are applied, the instrument meets its accuracy statements as required by ISO/IEC 17025:2005, or other applicable standards.

10.4 Media

The recommended calibration medium is dry nitrogen or clean dry instrument air. A height variation between the standard and the CPC6000 can cause significant errors. See "[10.9](#) - Head Pressure Correction" for further information.

10.5 Calibration Setup

Figure 10.5 - Calibration Setup illustrates a typical setup for either local or remote calibration for an absolute or gauge pressure instrument. In the illustration the 'Optional Computer' is required only for performing a remote calibration.

The 'Pressure Standard' is normally a deadweight test instrument, and the 'Volume Controller' refers to a hand operated variable-volume pressure vernier device. A diaphragm type vacuum gauge is recommended over the gauge tube type of vacuum sensor for calibrating sub-atmospheric pressures (see Figure 10.5 under "Setup for Absolute Pressure"). A vacuum source with a capacity of generating 600 millitorr is recommended.

Modular Precision Pressure Controller CPC6000

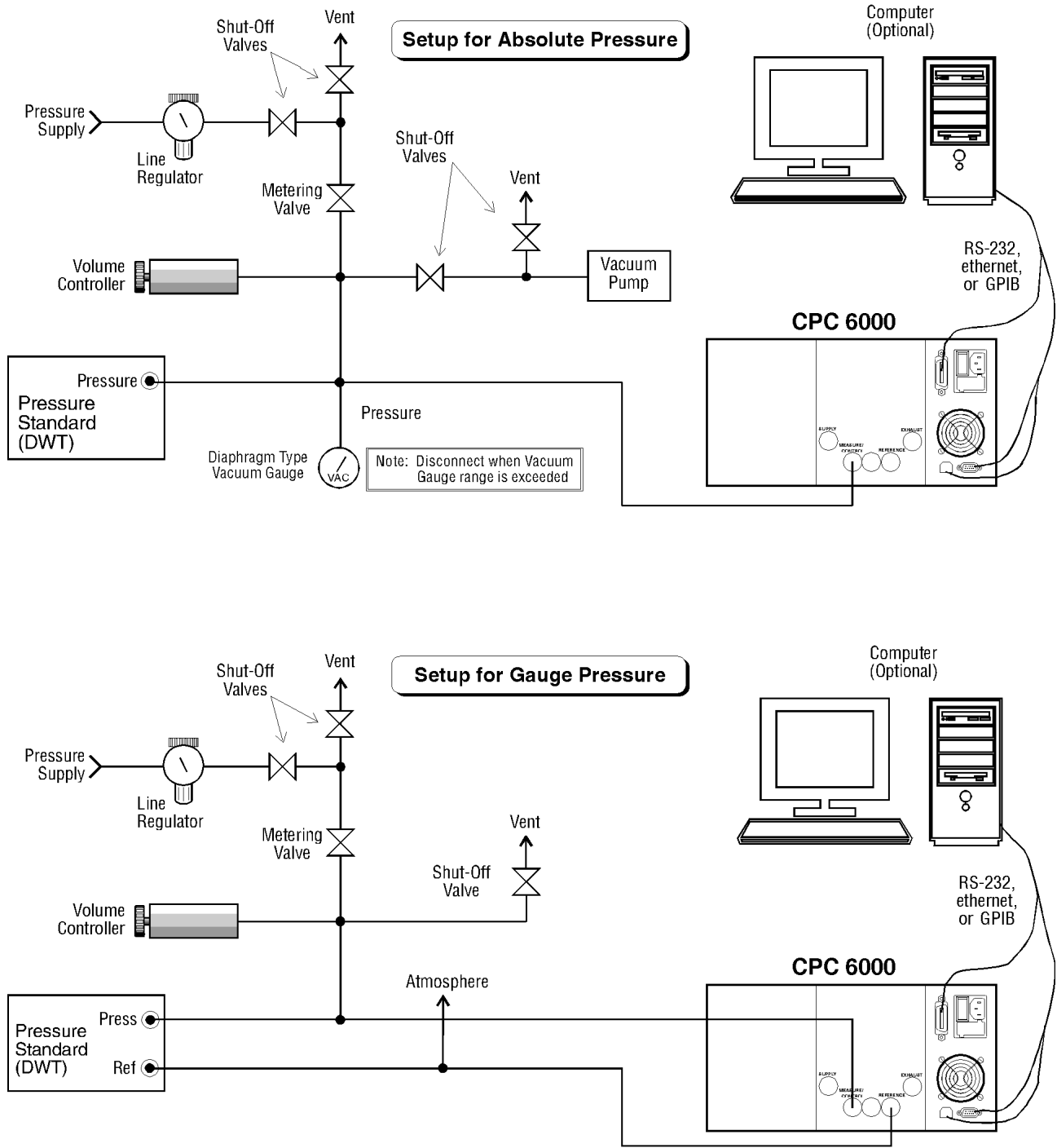

Figure 10.5 - Calibration Setup

To get to the Calibration screen press [Setup], [Sensor], and then press [Calibrate].

10.6 Password

Autozero does not require a password, however one is needed to change any date of calibration, Zero, Span, or to change the system password. The password installed at the factory was 1 2 3 4 5 6, but the user can change this as described below.

10.6.1 Change Password

To change the current password:

1. Press the [Calibrate] key to see the Calibration Data screen similar to Figure 10.6.1A. Notice the padlock.

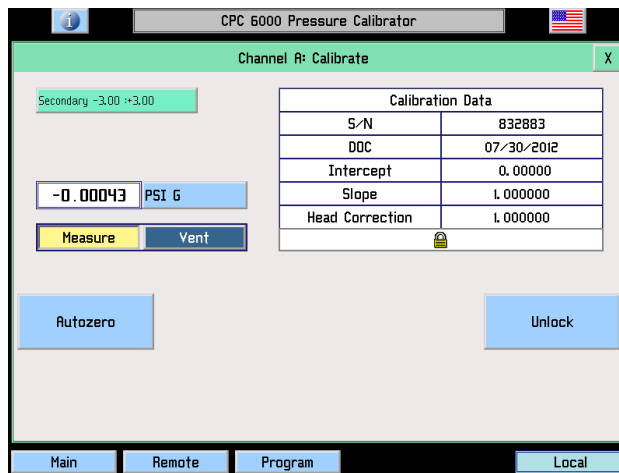

Figure 10.6.1A - Calibration Data Screen (locked)

2. Touch the [Unlock] key to display the Enter Password window as shown in Figure 10.6.1B.

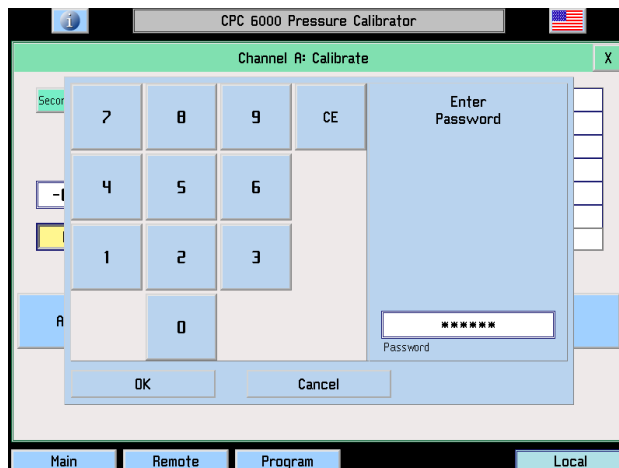

Figure 10.6.1B - 'Enter Password' Window

- Enter the current password. As each number is pressed an ‘*’ appears in the ‘Password’ window. When completed touch [OK] to unlock the calibration data screen.
- The Calibration Data screen of Figure 10.6.1C is displayed. Use this screen to change the password to perform functions for 1 point calibration, 2 point calibration, restore factory cal, and head correction. Touch [Change Password] and the Change Password window appears as in Figure 10.6.1D.

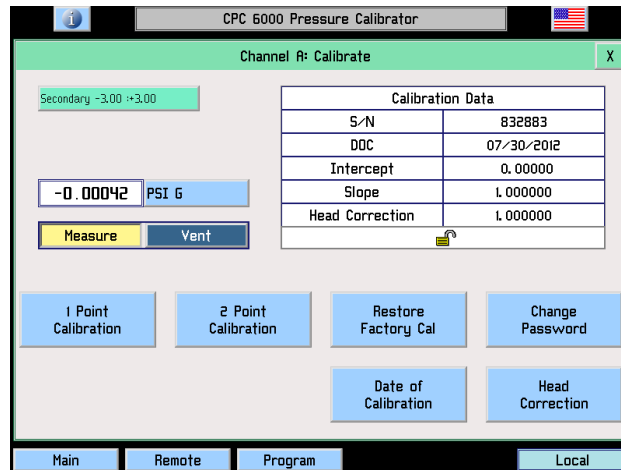

Figure 10.6.1C - Calibration Data Screen (unlocked)

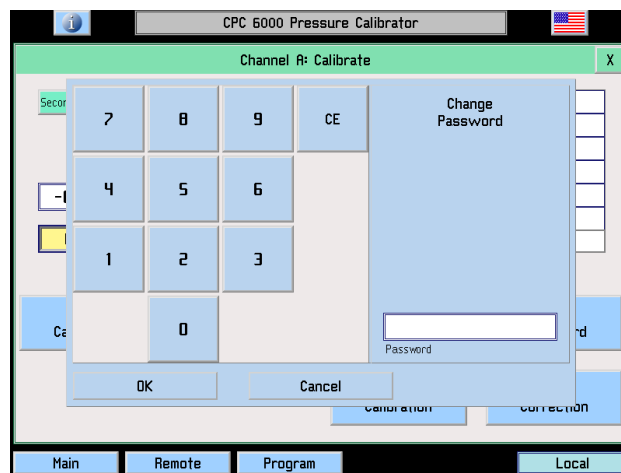

Figure 10.6.1D - “Change Password” Window

- At the Change Password screen enter from one to six digits for a new password. As each number is pressed it appears in the Password window.
- Before proceeding, review the displayed digits for accuracy. A mistake here could prevent future access to this screen. To make a correction use [CE] to backspace through the entries and then immediately re-enter the correct numbers.



CAUTION: The password is seldom used and is easily forgotten. After a change write down and save the new number. If the password is lost, contact Mensor.

7. When satisfied that the new password is correct, **and a written copy has been stored**, press [OK] to complete the entry. The previous password is immediately replaced by the new one.
8. Confirm that the new password is valid by pressing [Main], then repeat steps 1 through 3 to return to the Calibration Data screen (Figure 10.6.1C). If this screen can't be accessed using either the old or the new password contact Mensor.

10.7 Restoring a Mensor Calibration

The offset and slope values established for each turndown at the final factory calibration are stored in permanent memory within each transducer. These factory values can be restored at any time regardless of the number of subsequent calibrations. To restore the factory calibration to the active turndown, press [Restore Factory Cal] on the unlocked Data Entry screen seen in Figure 10.6.1C. This will restore both the factory zero offset and slope calibration values to the active turndown. The [Restore Factory Cal] function can be repeated for each turndown as desired.

10.8 On-site Calibration

The CPC6000 can contain one primary transducer and barometric reference and may have an additional, secondary transducer. Each transducer (except the Barometric Reference Transducer) can have up to two separately calibrated ranges (two turndowns). Zero and span adjustments are available for each of these turndowns.

Linearity is preset at the factory and is not adjustable. One and two point calibrations are used to make a linear correction to the pressure readings using the formula: (uncorrected reading) X slope) + offset. The one point calibration adjusts the offset, the two point calibration adjusts both the offset and the slope.

10.8.1 CPC6000 Preparation Procedure

The following is a step-by step instruction for calibrating a selected turndown.

Evacuate the pressure transducer(s) to a low pressure that will still maintain a viscous flow, typically 600 millitorr (0.0116 psi). At pressures lower than this the pressure at any particular point in the system is questionable. Allow from five to ten minutes for the target pressure to stabilize, then convert the millitorr reading to an equivalent instrument reading in the active measurement units. Table 11.3 in the [Appendix Section](#) lists millitorr conversion factors.

To begin a calibration, press the [Calibrate] tab and unlock the calibration screen as described in the previous section. Select the turndown to calibrate from the drop list and the units in which to perform the calibration on the unlocked calibration data screen.

10.8.2 [Calibrate] Setup Key

The Calibration screen shown in Figure 10.8.2A is the first of several screens relating to the calibration functions. This screen allows the user to perform any of the following tasks:

1. Calibrate zero and span values on any turndown open of all installed sensors. An Absolute CPC6000 allows calibration of the barometric reference transducer;
2. Establish a new Date of Calibration (DOC) for any turndown;

Modular Precision Pressure Controller CPC6000

3. Change the system password;
4. Autozero all turndowns at one time.

Notice the padlock icon on the display. This signifies that the indicated values on the screen are not able to be modified until the password has been entered.

[Unlock] Key: Touch [Unlock] (Figure 10.8.2A) to move on to the password screen. This function is password protected. Details on this function are included in the [Calibration section](#).

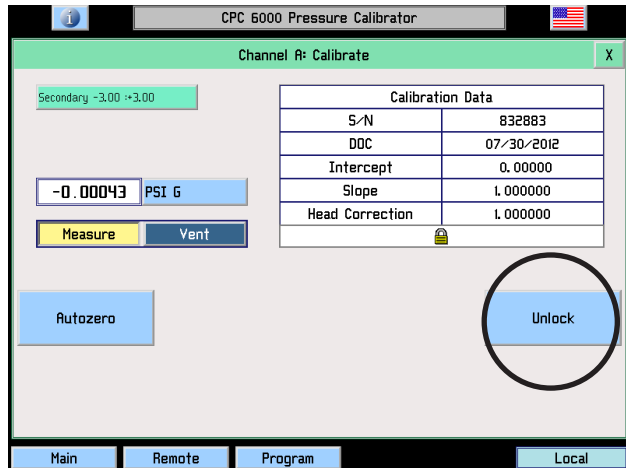

Figure 10.8.2A - Calibration Screen (locked)

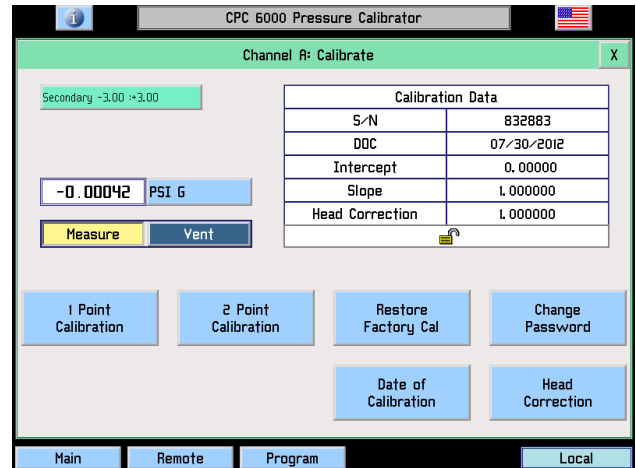

Figure 10.8.2B - Calibrate Screen (unlocked)

[Autozero] Key: Press this key to have the CPC6000 automatically re-zero all turndowns that can measure the vented pressure (Figure 10.8.2C).

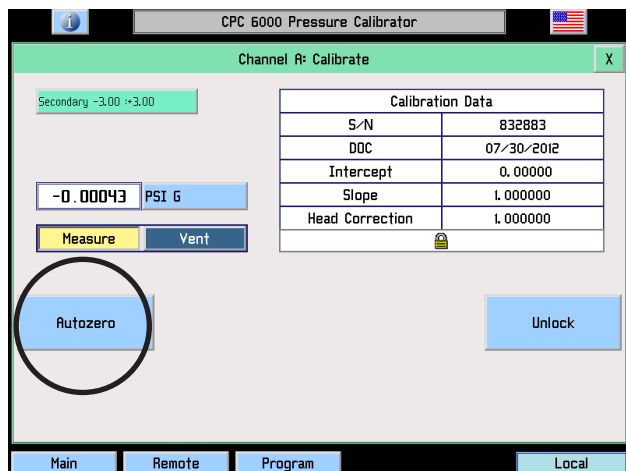

Figure 10.8.2C - [Autozero] Key

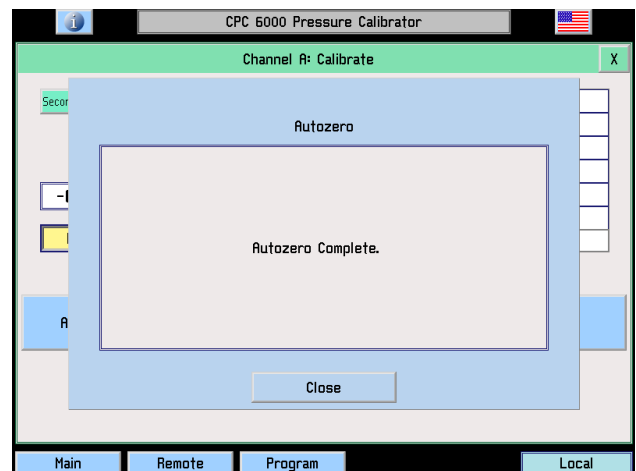

Figure 10.8.2D - Autozero Window

For an absolute CPC6000, this automatic function will:

1. Vent the system.
2. Select the turndown with the smallest span that can measure the vented pressure, or read the internal barometric reference if installed.
3. Record that pressure as “current barometric pressure”.
4. Adjust the zero offset of each turndown so the turndown’s output equals the “current barometric pressure”.

For a gauge CPC6000, this automatic function will:

1. Vent the system.
2. Adjust the zero offset of each turndown that can measure the vented pressure so the turndown's output is equal to zero.



Notice

The autozero function re-zeros sensors without storing the zero offsets through power cycling.

10.8.3 1-Point Calibration

A one-point calibration adjusts only the offset of the active turndown. From the unlocked calibration data screen, press the [1 Point Calibration] key shown in Figure 10.8.3A. The '1 Point Cal' window shown in Figure 10.8.3B will appear. This window shows the maximum and minimum acceptable values and the current reading. The [?] key pops up a help dialog with instructions on how to use this screen. Enter the current known pressure in the 'Desired Reading' data window. Values entered that are outside of the displayed Maximum/Minimum limits will not be accepted. When the desired reading is displayed in the data window press the [OK] key and the offset will be stored. The [Cancel] key will exit this window and not make any adjustments to the calibration of the active turndown.

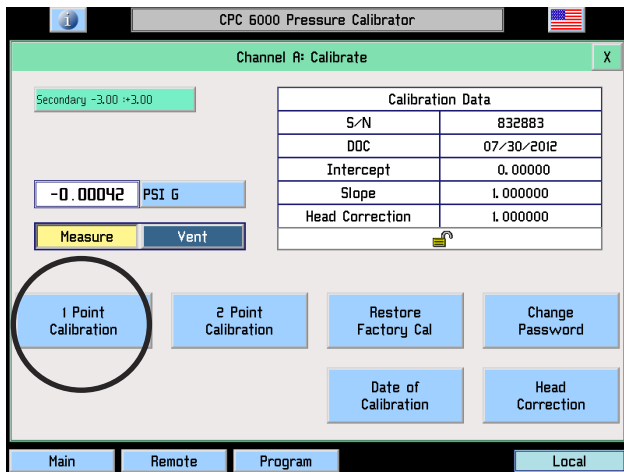

Figure 10.8.3A - [1 Point Calibration] Key

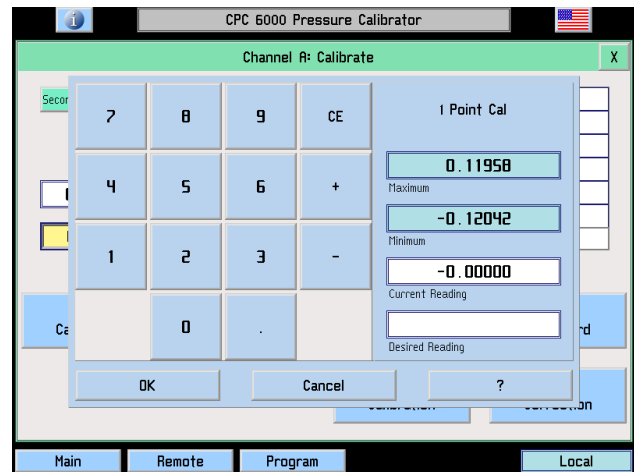

Figure 10.8.3B - 1 Point Cal Window

10.8.4 2-Point Calibration

A two-point calibration adjusts both the offset and the slope of the active turndown. The low point must be within 20% of the minimum range of the active turndown and the high point must be within 20% of the maximum range of the active turndown. Insure that the head correction is adjusted properly, see [Section 10.9](#). From the unlocked calibration data screen, press the [2 Point Calibration] key as shown in Figure 10.8.4A. The 'Low Point Cal' window illustrated in Figure 10.8.4B will appear. This window shows the maximum and minimum acceptable values and the current reading. The [?] key pops up a help dialog with instructions on how to use this window. Enter the current known pressure in the 'Desired Reading' data window and press the [OK] key.

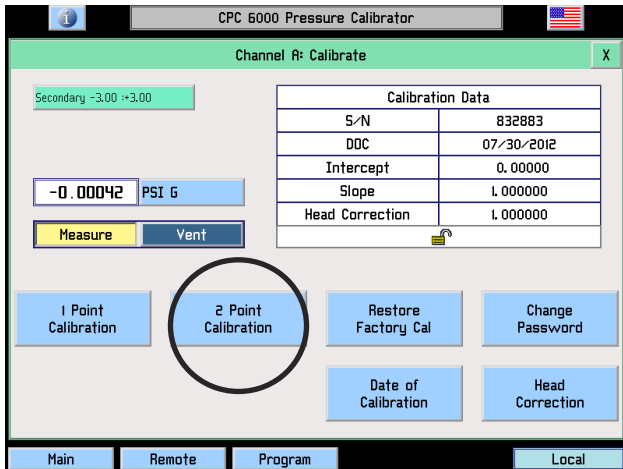

Figure 10.8.4A - [2 Point Calibration] Key

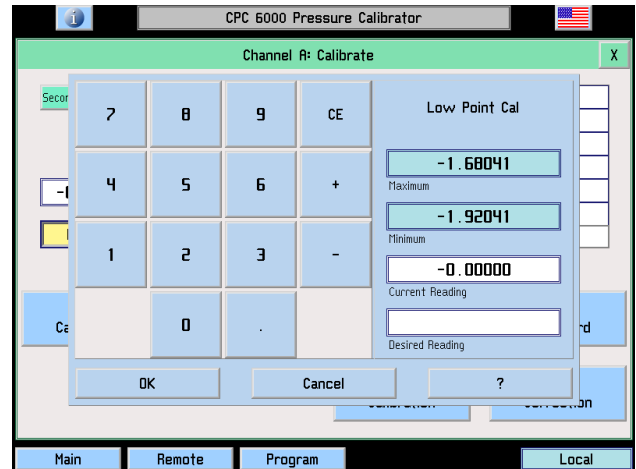

Figure 10.8.4B - Low Point Cal Window

The 'High Point Cal' window illustrated in Figure 10.8.4C will appear. It's function is identical to the 'Low Point Cal' window. Enter the new known pressure and press the [OK] key.

The [Cancel] key will exit either window and not make any adjustments to the calibration of the active turndown.

The 'Date of Calibration' window illustrated in Figure 10.8.4D will appear. Enter the date of calibration in a mm/dd/yyyy format exactly, including the '/' separation marks. Press the [OK] key and the new data of calibration will be saved to the turndown.

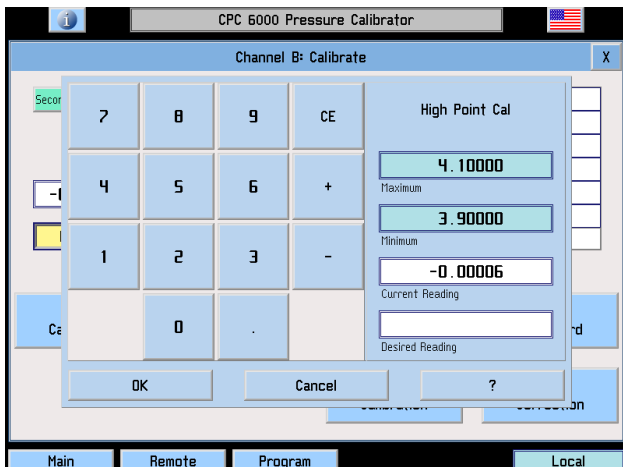

Figure 10.8.4C - High Point Cal Window

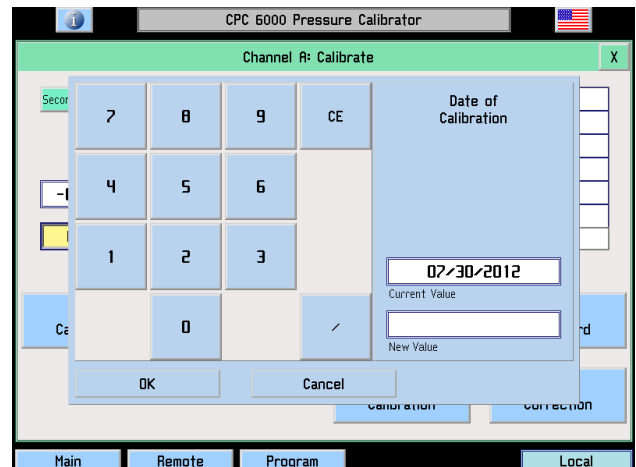

Figure 10.8.4D - Date of Calibration Window

10.9 Head Pressure Correction

The correction is accessed from the calibration menu. Four parameters may be set to reflect conditions at the operator’s site. Press either [English] or [Metric] units for entering head pressure correction information into the CPC6000. See Figure 10.9A.



Head correction parameters are stored separately for each channel.

Height: Enter the difference in height between the center of the measure/control port of the CPC6000 and the reference level of the Device Under Test (DUT). If the reference level of the DUT is lower than the center of the measure/control port of the CPC6000, enter a positive height. If it is higher, enter a negative height. See Figure 10.9B.

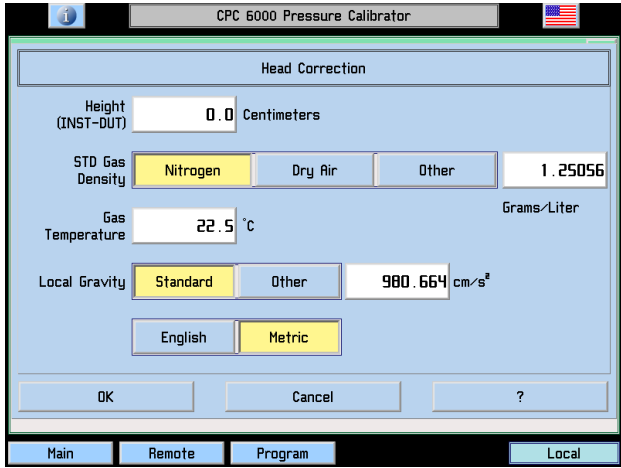

Figure 10.9A - Head Correction Screen

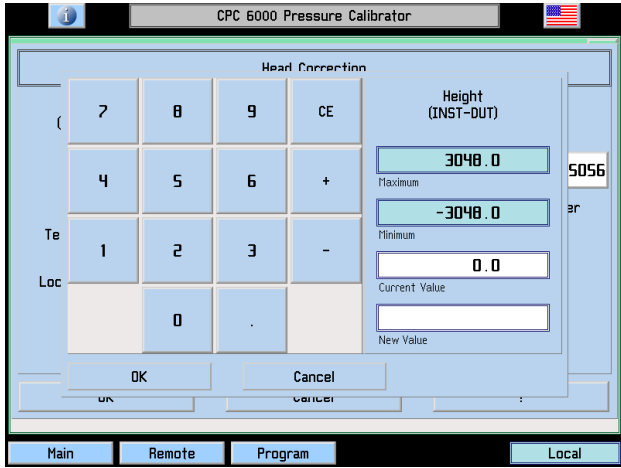

Figure 10.9B - Height Window

Gas Density: If nitrogen (N2) or dry air are being used as a pressure media, press the appropriate selection. If another gas is being used, enter the density for the gas at standard pressure and temperature in either lb/cubic foot (english) or kg/liter (metric) units. See Figure 10.9C.

Gas Temperature: Enter the average gas temperature in degrees F or C. If unsure of the gas temperature, use 68 F. See Figure 10.9D.

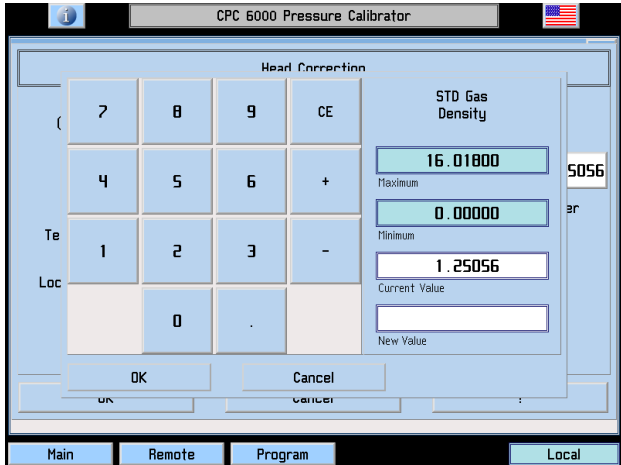

Figure 10.9C - Gas Density

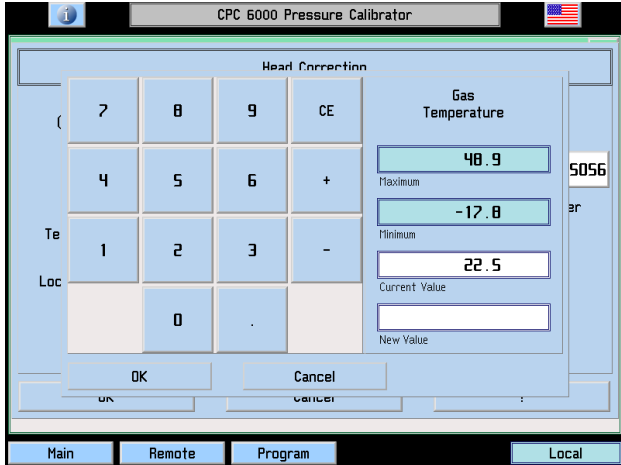

Figure 10.9D - Gas Temperature

Local Gravity: Enter the local gravity acceleration value. If unsure, use the standard gravity ratio button. See Figure 10.9E.

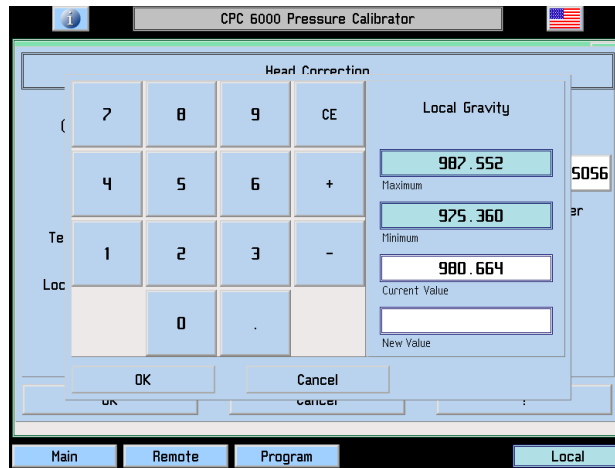

Figure 10.9E - Local Gravity

Table 10.9 - Head Pressure Correction Limits

Height	±1200 inches
Density	0 to 1 lb/cu ft
Temperature	0 to 120 F
Gravity	32 to 32.4 ft/sec ²

11. Appendix

11.1 Measurement Units

The Units command selects the measurement units to be output on the bus and the display.

Table 11.1 – Measurement Units (unitno)

Code	Description	Output Format
1	pounds per square inch	psi
2	inches of mercury @0C	inHg @0C
3	inches of mercury @60F	inHg @60F
4	inches of water @4C	inH2O @4C
5	inches of water @20C	inH2O @20C
6	inches of water @60F	inH2O @60F
7	feet of water @4C	ftH2O @4C
8	feet of water @20C	ftH2O @20C
9	feet of water @60F	ftH2O @60F
10	millitorr	mTorr
11	inches of seawater @0C 3.5% salinity	inSW @0C
12	feet of seawater @0C 3.5% salinity	ftSW @0C
13	atmospheres	atm
14	bars	bar
15	millibars	mbar
16	millimeters of water @4C	mmH2O @4C
17	centimeters of water @4C	cmH2O @4C
18	meters of water @4C	mH2O @4C
19	millimeters of mercury @0C	mmHg @0C
20	centimeters of mercury @0C	cmHg @0C
21	torr	Torr
22	kilopascals	kPa
23	pascals	Pa
24	dyne per square centimeter	dyn/sq cm
25	grams per square centimeter	g/sq cm
26	kilograms per square centimeter	kg/sq cm
27	meters of seawater @0C 3.5% salinity	mSW @0C
28	ounce per square inch	oz/si
29	pounds per square foot	psf
30	tons per square foot	tons/sq ft
31	percent of full scale	%FS
32	micron Hg @0C	micronHg @0C
33	ton per square inch	tons/sq in
34	n/a	n/a

Modular Precision Pressure Controller CPC6000

35	hectopascals	hPa
36	megapascals	MPa
37	millimeters of water @20C	mmH2O @20C
38	centimeter of water @20C	cmH2O @20C
39	meters of water @20C	mH2O @20C
n/a	User Units 1	User defined
n/a	User Units 2	User defined

11.2 Conversion Factors, psi

The values listed in the column “To convert from psi” are the values imbedded in the instrument program. The values listed under “To convert to psi” are internally calculated approximations based on the imbedded values.

Table 11.2 – Conversion Factors, psi

Code	Pressure Unit	To convert from psi	To convert to psi
1	psi	1	1
2	inHg @0C	2.036020	0.4911544
3	inHg @60F	2.041772	0.4897707
4	inH2O @4C	27.68067	0.03612629
5	inH2O @20C	27.72977	0.03606233
6	inH2O @60F	27.70759	0.03609119
7	ftH2O @4C	2.306726	0.4335149
8	ftH2O @20C	2.310814	0.4327480
9	ftH2O @60F	2.308966	0.4330943
10	mTorr	51715.08	0.00001933672
11	inSW @0C 3.5% salinity	26.92334	0.03714250
12	ftSW @0C 3.5% salinity	2.243611	0.445710
13	atm	0.06804596	14.69595
14	bar	0.06894757	14.50377
15	mbar	68.94757	0.01450377
16	mmH2O @4C	703.0890	0.001422295
17	cmH2O @4C	70.30890	0.01422295
18	mH2O @4C	0.7030890	1.422295
19	mmHg @0C	51.71508	0.01933672
20	cmHg @0C	5.171508	0.1933672
21	Torr	51.71508	0.01933672
22	kPa	6.894757	0.1450377
23	Pa	6894.757	0.0001450377
24	dyn/sq cm	68947.57	0.00001450377
25	g/sq cm	70.30697	0.01422334
26	kg/sq cm	0.07030697	14.22334
27	mSW @0C 3.5% salinity	0.6838528	1.462303

28	oz/si	16	0.0625
29	psf	144	0.006944444
30	tons/sq ft	0.072	13.88889
31	%FS	(psi / range) x 100	(% FS x range) / 100
32	micronHg @0C	51715.08	0.00001933672
33	tons/sq in	0.0005	2000
35	hPa	68.94757	0.01450377
36	MPa	0.006894757	145.0377
37	mmH2O @20C	704.336	0.001419777
38	cmH2O @20C	70.4336	0.01419777
39	mH2O @20C	0.704336	1.419777

11.3 Conversion Factors, Millitorr

The following table lists factors which should be used as multipliers when converting other pressure units to or from millitorr.

Table 11.3 – Conversion Factors, millitorr

Code	Pressure Unit	To convert from millitorr	To convert to millitorr
1	psi	0.00001933672	51715.08
2	inHg @0C	0.00003936995	25400.08909
3	inHg @60F	0.00003948117	25328.53093
4	inH2O @4C	0.0005352534	1868.273977
5	inH2O @20C	0.0005362028	1864.966281
6	inH2O @60F	0.0005357739	1866.458778
7	ftH2O @4C	0.00004460451	22419.25773
8	ftH2O @20C	0.00004468356	22379.59744
9	ftH2O @60F	0.00004464783	22397.50637
10	mTorr	1.0	1.000000022
11	inSW @0C 3.5% salinity	0.0005206091	1920.827359
12	ftSW @0C 3.5% salinity	0.00004338408	23049.92831
13	atm	0.000001315786	760002.2299
14	bar	0.000001333220	750063.6259
15	mbar	0.001333220	750.0636259
16	mmH2O @4C	0.0135954	73.5540997
17	cmH2O @4C	0.001359544	735.5409971
18	mH2O @4C	0.00001359544	73554.09971
19	mmHg @0C	0.001	1000.000022
20	cmHg @0C	0.0001	10000.00022
21	Torr	0.001	1000.000022
22	kPa	0.0001333220	7500.636259
23	Pa	0.1333220	7.500636259

Modular Precision Pressure Controller CPC6000

24	dyn/sq cm	1.333220	0.750063626
25	g/sq cm	0.001359506	735.561166
26	kg/sq cm	0.000001359506	735561.166
27	mSW @0C 3.5% salinity	0.00001322347	75623.11663
28	oz/si	0.0003093875	3232.1992
29	psf	0.002784488	359.132477
30	tons/sq ft	0.000001392244	718265.0575
32	micronHg @0C	1.0	1.000000022
33	tons/sq in	n/a	n/a
35	hPa	0.001333220	750.0636259
36	MPa	0.0000001333220	7500636.259
37	mmH2O @20C	0.01361955	73.42388114
38	cmH2O @20C	0.001361955	734.2388114
39	mH2O @20C	0.00001361955	73423.88114

11.4 Conversion Factors, Pascal

The following table lists factors which should be used as multipliers when converting other pressure units to or from Pascal.

Table 11.4 – Conversion Factors, Pascal

Unit No.	Pressure Unit	To convert from Pascal	To convert to Pascal
1	psi	1.450377E-04	6.894757E+03
2	inHg @0C	2.952997E-04	3.386390E+03
3	inHg @60F	2.961339E-04	3.376850E+03
4	inH2O @4C	4.014741E-03	2.490820E+02
5	inH2O @20C	4.021862E-03	2.486410E+02
6	inH2O @60F	4.018645E-03	2.488400E+02
7	ftH2O @4C	3.345622E-04	2.988980E+03
8	ftH2O @20C	3.351551E-04	2.983692E+03
9	ftH2O @60F	3.348871E-04	2.986080E+03
10	mTorr	7.500636E+00	1.333220E-01
11	inSW @0C 3.5% salinity	3.904899E-03	2.560885E+02
12	ftSW @0C 3.5% salinity	3.254082E-04	3.073062E+03
13	atm	9.869230E-06	1.013250E+05
14	bar	1.00000E-05	1.00000E+05
15	mbar	1.00000E-02	1.00000E+02
16	mmH2O @4C	1.019744E-01	9.806378E+00
17	cmH2O @4C	1.019744E-02	9.806378E+01
18	mH2O @4C	1.019744E-04	9.806378E+03
19	mmHg @0C	7.500636E-03	1.333220E+02
20	cmHg @0C	7.500636E-04	1.333220E+03

21	Torr	7.500636E-03	1.333220E+02
22	kPa	1.00000E-03	1.00000E+03
23	Pa	1.00000E+00	1.00000E+00
24	dyn/sq cm	1.00000E+01	1.00000E-01
25	g/sq cm	1.019716E-02	9.806647E+01
26	kg/sq cm	1.019716E-05	9.806647E+04
27	mSW @0C 3.5% salinity	9.918444E-05	1.008222E+04
28	oz/si	2.320603E-03	4.309223E+02
29	psf	2.088543E-02	4.788025E+01
30	tons/sq ft	1.044271E-05	9.576052E+04
32	micronHg @0C	7.500636E+00	1.333220E-01
33	tons/sq in	7.251885E-08	1.378951E+07
35	hPa	1.00000E-02	1.00000E+02
36	MPa	1.00000E-06	1.00000E+06
37	mmH2O @20C	1.021553E-01	9.789017E+00
38	cmH2O @20C	1.021553E-02	9.789017E+01
39	mH2O @20C	1.021553E-04	9.789017E+03



Mensor

201 Barnes Drive
San Marcos, Tx 78666
Tel: 1.512.396.4200
1.800.984.4200 (USA only)
web site: www.mensor.com
fax: 1.512.396.1820
e-mail: sales@mensor.com
tech.support@mensor.com



WIKAI Alexander Wiegand SE & Co. KG

Alexander-Wiegand-Straße 30
D-63911 Klingenberg / Germany
TEL: (+49) 93 72/132-9986
WEB SITE: www.wika.de
FAX: (+49) 93 72/132-8767
E-MAIL: testequip@wika.de